



538204-01

01

02

03

04

05

06

07

08

09

10

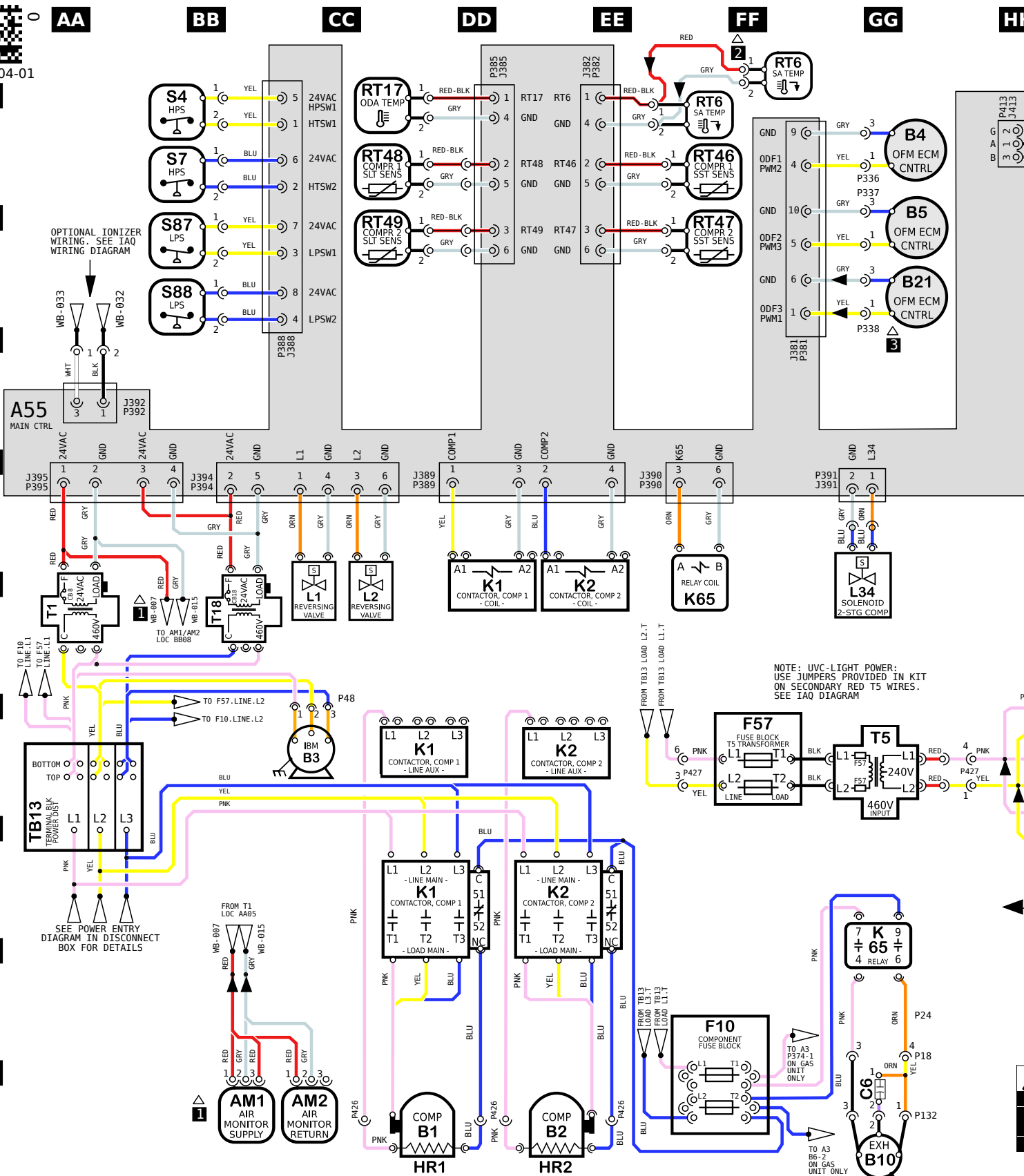

KEY LIST		
LOCATION	COMPONENT DESCRIPTION	
BB09	AM1, AM2	AIR MONITOR, SUPPLY/RETURN, IAQ-TVOC
DD/EE10	B1, B2	COMPRESSOR 1, 2
CC06, JJ01	B3	MOTOR, BLOWER
GG02, HH07	B4, B5, B21	MOTOR, OUTDOOR FAN 1, 2, 3
GG10	B10	MOTOR, EXHAUST FAN 1
GG09	C6	CAPACITOR, EXHAUST FAN 1
FF09	F10	FUSE, COMPONENT
FF06	F57	FUSE, T5 TRANSFORMER
DD/EE10	HR1, HR2	HEATER, COMPRESSOR 1, 2
DD/EE05, 08, 08	K1, K2	CONTACTOR, COMPRESSOR 1, 2
FF05, GG08	K65	RELAY, EXHAUST FAN 1
CC05	L1, L2	VALVE, REVERSING 1,2
GG05	L34	SOLENOID, TWO STAGE, COMPRESSOR 1
FF01	RT6	SENSOR, A55 DISCHARGE (IMC)
CC01	RT17	SENSOR, OUTSIDE AIR TEMP
FF02	RT46, RT47	SENSOR, SAT. SUCT TEMP., COMP 1, 2
CC02	RT48, RT49	SENSOR, SAT. LIQUID TEMP., COMP 1, 2
BB01/02	S4, S7	LIMIT, HI PRESS., SWITCH, COMP 1, 2
BB02/03	S87, S88	SWITCH, LOW PRESS., COMP. 1, 2
AA05	T1	TRANSFORMER, CONTROL
GG06	T5	TRANSFORMER, OUTDOOR FAN MOTOR
BB05	T18	TRANSFORMER, CONTACTOR
AA07	TB13	TERMINAL STRIP, POWER DISTRIBUTION

NOTE: UVC-LIGHT POWER:
USE JUMPERS PROVIDED IN KIT
ON SECONDARY RED T5 WIRES.
SEE IAQ DIAGRAM

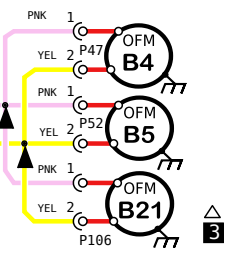

WARNING
DISCONNECT ALL POWER BEFORE SERVICING.
ELECTRIC SHOCK HAZARD, CAN CAUSE INJURY OR DEATH. UNIT MUST BE GROUNDED IN ACCORDANCE WITH NATIONAL AND LOCAL CODES.
FOR USE WITH COPPER CONDUCTORS ONLY. REFER TO UNIT RATING PLATE FOR MINIMUM CIRCUIT AMPACITY AND MAXIMUM OVERCURRENT PROTECTION SIZE.
IF ANY WIRE IN THIS APPLIANCE IS REPLACED, IT MUST BE REPLACED WITH WIRE OF LIKE SIZE, RATING AND INSULATION THICKNESS.

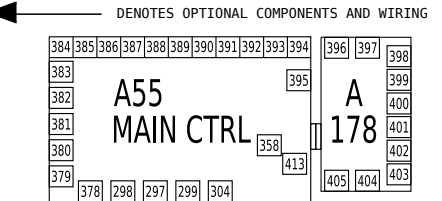

NOTES	
1	IAQ SENSORS OPTIONAL
2	FOR REMOTE LOCATION OF RT6, ADD THE EXTENSION HARNESS
3	B21 USED ON 10 AND 12.5-TON UNITS ONLY

Product: LHT, LDT B Box - G VOLT
Heat Pump Diagram with Higher SCCR

Voltage: 460V/3~/60Hz (G)
Supersedes: XXXXX-XX Form No: 538204-01 Rev: 0

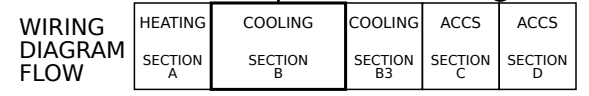

10x12 CUT SIZE

REV	EC NO.	DATE	BY	APVD	REVISION NOTE
---	CN-010219	07-25-2022	RXJ	JDH	ORIGINATED AT PD&R CARROLLTON, TX.



538204-01

01

02

03

04

05

06

07

08

09

10

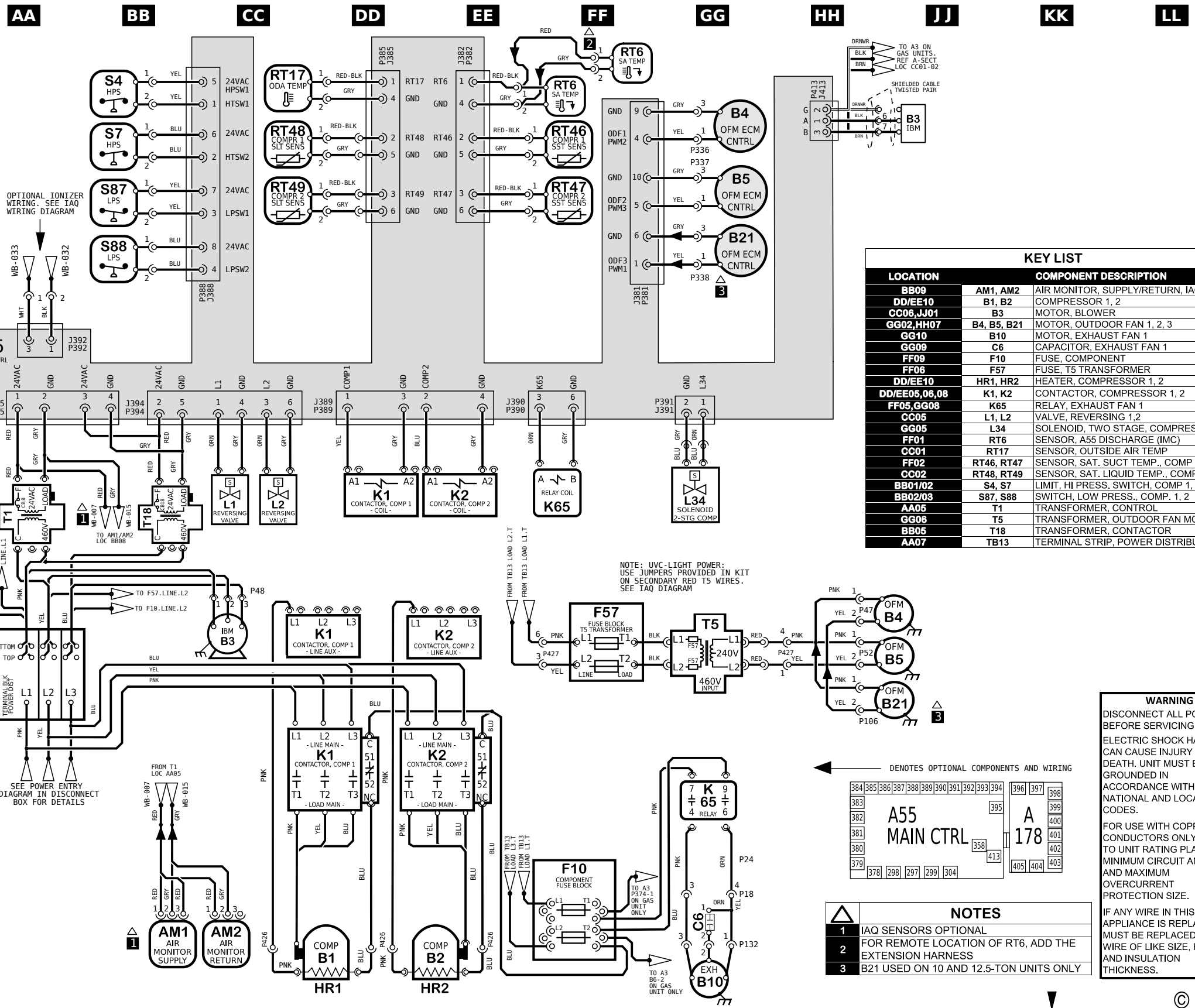

LOCATION	COMPONENT DESCRIPTION
BB09	AM1, AM2 AIR MONITOR, SUPPLY/RETURN, IAQ-TVOC
DD/EE10	B1, B2 COMPRESSOR 1, 2
CC06, JJ01	B3 MOTOR, BLOWER
GG02, HH07	B4, B5, B21 MOTOR, OUTDOOR FAN 1, 2, 3
GG10	B10 MOTOR, EXHAUST FAN 1
GG09	C6 CAPACITOR, EXHAUST FAN 1
FF09	F10 FUSE, COMPONENT
FF06	F57 FUSE, T5 TRANSFORMER
DD/EE10	HR1, HR2 HEATER, COMPRESSOR 1, 2
DD/EE05, 08, 08	K1, K2 CONTACTOR, COMPRESSOR 1, 2
FF05, GG08	K65 RELAY, EXHAUST FAN 1
CC05	L1, L2 VALVE, REVERSING 1,2
GG05	L34 SOLENOID, TWO STAGE, COMPRESSOR 1
FF01	RT6 SENSOR, A55 DISCHARGE (IMC)
CC01	RT17 SENSOR, OUTSIDE AIR TEMP
FF02	RT46, RT47 SENSOR, SAT. SUCT TEMP., COMP 1, 2
CC02	RT48, RT49 SENSOR, SAT. LIQUID TEMP., COMP 1, 2
BB01/02	S4, S7 LIMIT, HI PRESS. SWITCH, COMP 1, 2
BB02/03	S87, S88 SWITCH, LOW PRESS., COMP. 1, 2
AA05	T1 TRANSFORMER, CONTROL
GG06	T5 TRANSFORMER, OUTDOOR FAN MOTOR
BB05	T18 TRANSFORMER, CONTACTOR
AA07	TB13 TERMINAL STRIP, POWER DISTRIBUTION

WARNING
DISCONNECT ALL POWER BEFORE SERVICING.
ELECTRIC SHOCK HAZARD, CAN CAUSE INJURY OR DEATH. UNIT MUST BE GROUNDED IN ACCORDANCE WITH NATIONAL AND LOCAL CODES.
FOR USE WITH COPPER CONDUCTORS ONLY. REFER TO UNIT RATING PLATE FOR MINIMUM CIRCUIT AMPACITY AND MAXIMUM OVERCURRENT PROTECTION SIZE.
IF ANY WIRE IN THIS APPLIANCE IS REPLACED, IT MUST BE REPLACED WITH WIRE OF LIKE SIZE, RATING AND INSULATION THICKNESS.

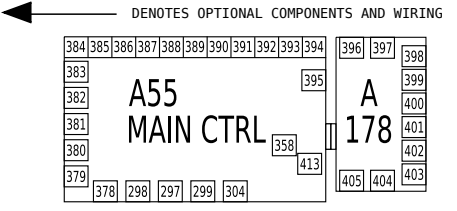

NOTES	
1	IAQ SENSORS OPTIONAL
2	FOR REMOTE LOCATION OF RT6, ADD THE EXTENSION HARNESS
3	B21 USED ON 10 AND 12.5-TON UNITS ONLY

Product: LHT, LDT B Box - G VOLT
Heat Pump Diagram with Higher SCCR

Voltage: 460V/3~/60Hz (G)
Supersedes: XXXXX-XX Form No: 538204-01 Rev: 0

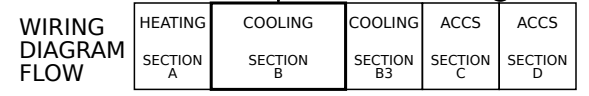

REV	EC NO.	DATE	BY	APVD	REVISION NOTE
---	CN-010219	07-25-2022	RXJ	JDH	ORIGINATED AT PD&R CARROLLTON, TX.