

INSTALLATION/ OPERATION INSTRUCTIONS

V0STAT51P-3 Touch Screen Programmable Local Controller



CONTROLS

507900-01

03/2019

General

The V0STAT51P-3 is a wired touch screen programmable local controller for VRF Heat Recovery and Heat Pump indoor units with convenient timed schedules for daily operation. These instructions are intended as a general guide and do not supersede local codes in any way. Consult authorities having jurisdiction before installation.

⚠ WARNING

Improper installation, adjustment, alteration, service or maintenance can cause property damage, personal injury or loss of life.

Installation and service must be performed by a licensed professional HVAC installer (or equivalent) or service agency.

⚠ CAUTION

To ensure proper system performance and reliability, Lennox does not recommend operation of VRF systems during any phase of construction. Construction debris, low temperatures, harmful vapors, and operation of the unit with misplaced filters can damage the units. Failure to follow these guidelines will result in the warranty being voided.

⚠ IMPORTANT

Frequent changes to operating mode may cause system malfunction. Allow at least one minute between mode changes to allow the system to stabilize.

This manual must be left with the owner for future reference.

Requirements

Be sure that power supply has been turned off before beginning installation. This controller should be used only as described in this manual.

Shipping and Packing List

Package 1 of 1 contains;

- 1 – Wired Controller
- 1 – CR2032 Lithium battery
- 2 – Phillips screws
- 2 – Plastic spacers
- 2 – 1/8" polymer toggle anchors
- 1 – Installation and operation manual

Tools Needed

- #2 Phillips screwdriver
- Slotted precision screwdriver
- Level
- 1/8" wall anchor tools

Controller Placement

Avoid installing local controller in high load or heat loss areas such as exterior walls or walls that are against unconditioned spaces, near entry doors and windows, or where direct sunlight may be present.

Contents

General	1
Requirements	1
Shipping and Packing List	1
Tools Needed	1
Controller Placement	1
Installation	4
Connecting to One Indoor Unit	5
Connecting to Multiple Indoor Units	6
Mounting the Controller	7
Home Screen Display	10
Operation	14
ON/OFF	14
Error Code Display	15
Mode Settings	16
Cooling Mode Operation	16
Heating Mode Operation	17
Auto Mode Operation	18
Dry Mode Operation	20
Fan-Only Operation	21
Temperature Setpoint	22
Space Temperature and Space Humidity Display	23
Temperature Unit Switching (°F/°C)	24
Fan Speed	25
Swing	26
Weekly Schedule Settings Quick Access	27
Override Settings	28
Schedule Management	29
Setup Schedule Templates	31
Paste a Schedule	32
Copy and Paste a Schedule Template	32
Copy a Schedule	32
Rename a Schedule Template	34
Delete a Schedule Template	35
Add a Daily Schedule Action	36
Delete a Daily Schedule Action	37
Rename a Daily Schedule Action	37
Edit a Daily Schedule Action	38
Setup a Weekly Schedule	39
Tap the Add button	40
Rename a Weekly Schedule	41
Delete a Weekly Schedule	42
Modify a Weekly Schedule	43
Select the Weekly Schedule to Use	44
Setup Holiday and Special Day Schedules	45
Add a Holiday and Special Day Schedule	46
Rename a Holiday and Special Day Schedules	47
Modify a Holiday and Special Day Schedules	48
Delete a Holiday and Special Day Schedules	49
Override Scheduled Settings	50
General Settings Configuration	52
Time Format Settings	53
Time Settings	53
Theme Settings	54

Brightness Settings	54
Controller Touch Tone (Sound) Settings.....	55
Standby Interface (Screen Saver) Settings	56
Standby (Screen Saver) Duration Settings	57
Swing Angle Settings.....	58
Daylight Savings Time Settings.....	58
Room Temperature and Humidity Display Settings	61
Contractor Information Input.....	62
Service Menu.....	63
Access Service Menu.....	63
Change Password	64
Master / Sub Wired Controller Settings	65
Master / Sub Wired Controller Operation	66
Indoor Unit Address Settings.....	68
Indoor Unit Display Board & Buzzer (Sound) Settings	69
Room Temperature Sensor Settings	70
Auto Mode Settings	72
Draft (Cold Blow) Prevention Settings	74
Stand-by Fan Speed Settings.....	75
Indoor Unit Static Pressure Settings.....	76
Occupancy Sensor Function Settings	77
Dry Mode Settings	78
Auxiliary / Alternate Heat Settings	79
Setpoint Limit Settings.....	81
Locking Function Settings	82
Advanced Information.....	83
Device Operation Information Query.....	84
Device Operation Error History Query.....	86
HHE Dry Contact Relay Interface Status Query.....	90
Controller Information.....	91
Firmware and Setting Information	92
Software Version	93
Controller Software Update	94
Indoor Unit Software Update	96
Setting Parameters Backup.....	99
Setting Parameters Import	100
Reset Settings	101
Help	102
Get On-screen Help	102

Installation

⚠ WARNING

Be sure that power supply has been turned off before beginning installation. Do not operate controller with wet hands.

⚠ CAUTION

Do not install controller in areas where harmful gases containing sulfur or other damaging agents may exist or the controller may be damaged. Clean controller using a clean, damp cloth. Do not spray cleanser on or around controller.

⚠ IMPORTANT

Electrostatic discharge can affect electronic components. Take precautions to neutralize electrostatic charge by touching your hand and tools to metal prior to handling the control.

⚠ IMPORTANT

Read all of the information in this manual before using this controller. All wiring must conform to local and national building and electrical codes and ordinances. This is a 12 VDC controller. Do not install on voltages higher than 12 VDC.

- This manual provides the installation instructions for this controller. Refer to the included wiring diagrams to connect the controller to the indoor unit.
- The controller uses low voltage. Keep a minimum distance of 12" (305 mm) between low voltage control wire and high voltage power wires.

Power wiring between controller and first indoor unit:

- Minimum 18 AWG stranded, shielded cable up to 164 feet (50 m).
- Ensure there are no gaps between the controller back cover and the mounting surface.
- Fill any holes in the wall behind the controller to avoid false readings from infiltration.
- Ground the shielded control wiring.
- Do not use a megger to test insulation.

Communication wiring between indoor units:

- Minimum 18 AWG stranded, shielded cable.

Connecting to One Indoor Unit

Connect the controller to one indoor unit main control board using 4-conductor shielded 18 GA cable. Connect to terminals 12V,COM,HA,HB. See Figure 1.

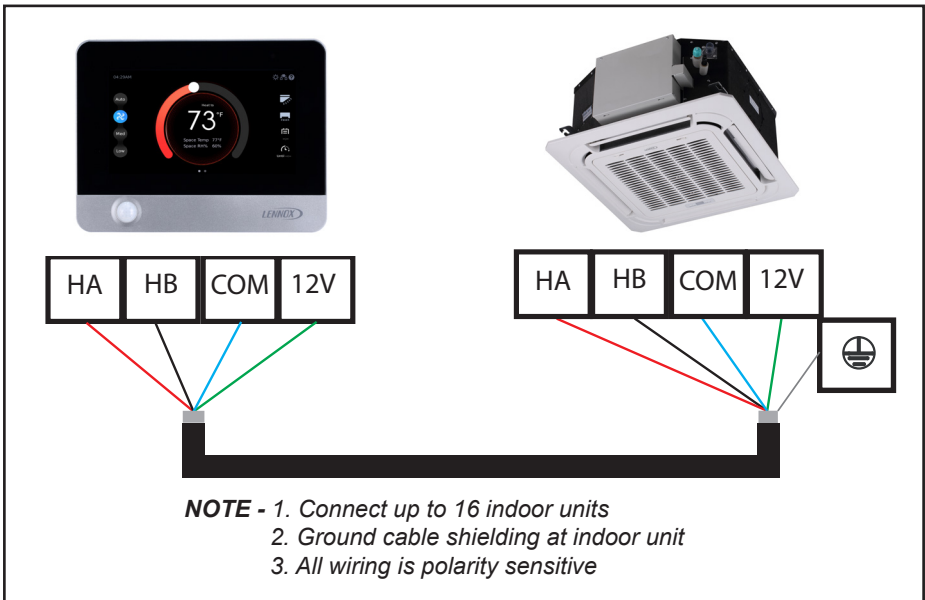

Figure 1. Connect Controller to Single Indoor Unit Wiring Connections

Connecting to Multiple Indoor Units

Connect the controller to multiple indoor units, up to 16. Use 4-conductor shielded cable to connect to the first indoor unit, then daisy chain control wiring to each indoor unit using the HA/HB terminals in the electrical control box of the indoor unit. Do not daisy chain 12V power cable. See Figure 2.

NOTE – All of the indoor units connected to the controller must be on the same refrigerant circuit, connected to the same outdoor unit.

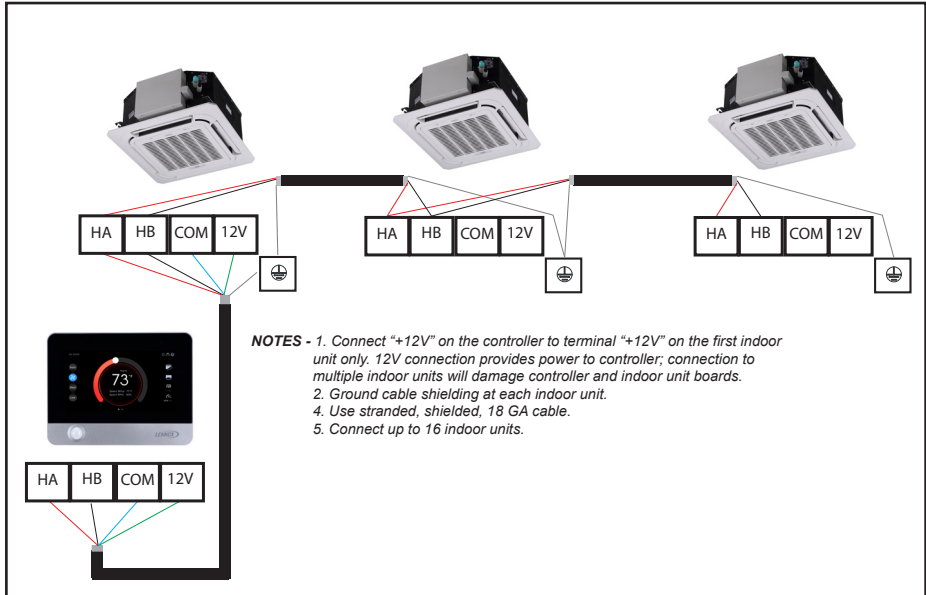

Figure 2. Connect Controller to Multiple Indoor Units Wiring Connections

⚠ CAUTION

Connect "12V" on the controller to terminal "12V" on the first indoor unit only. 12V connection provides power to controller; connection to multiple indoor units will damage controller and indoor unit boards.

Mounting the Controller

1. Remove the back cover from the controller. See Figure 3.

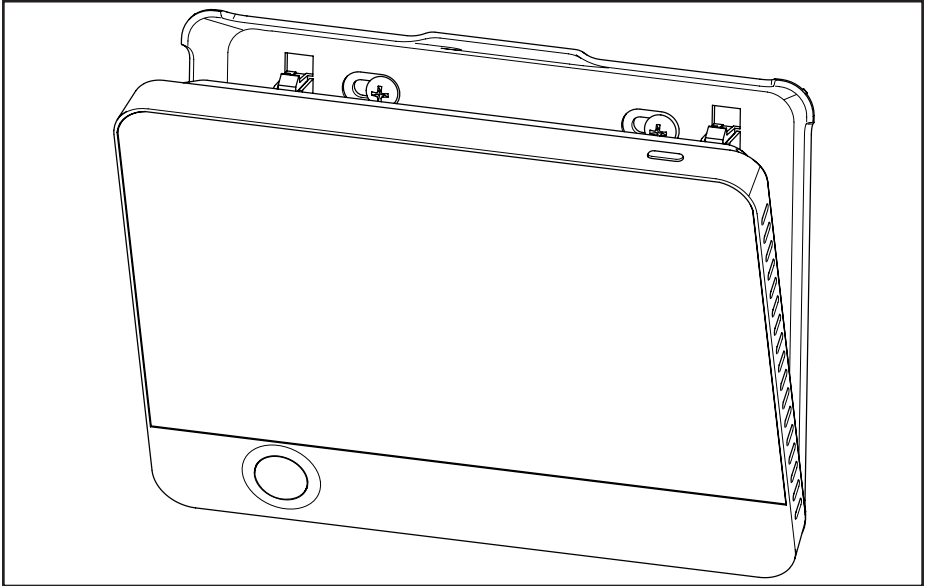

Figure 3. Remove Back Cover from Controller

2. Attach the back cover to the wall using screws. See Figure 4.

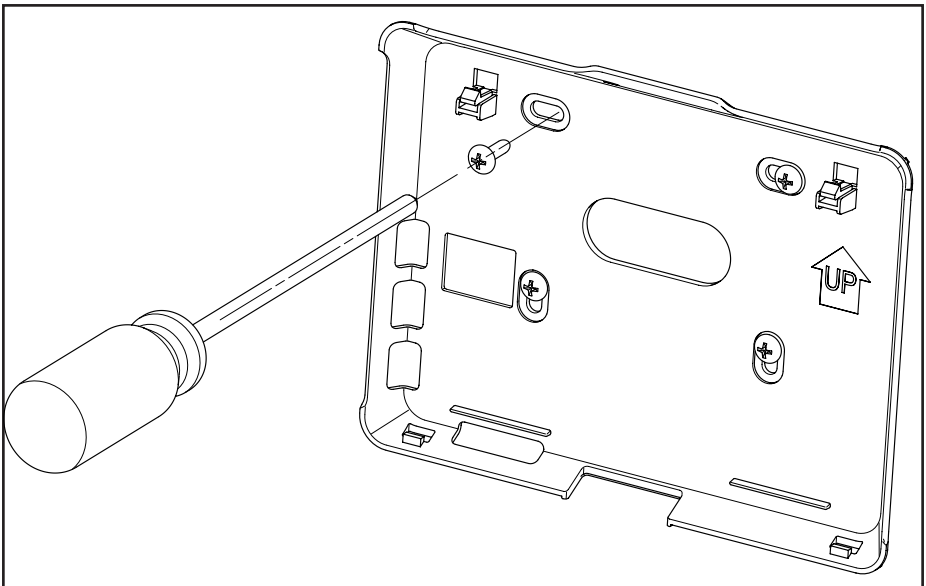

Figure 4. Attach Back Cover to Wall

3. Connect the controller to one indoor unit main control board using 4-conductor shielded 18 GA cable. Connect to terminals 12V,COM,HA,HB on the back of the controller.

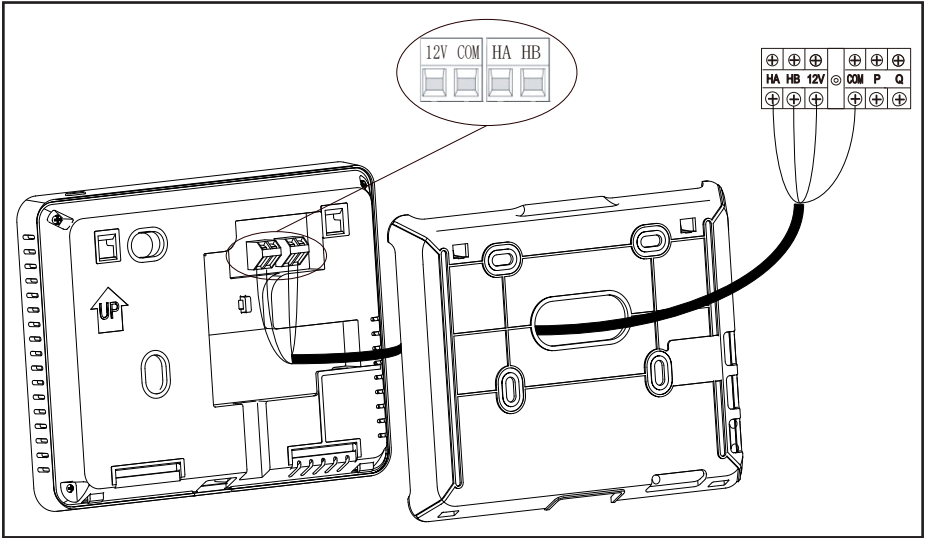

Figure 5. Connect Cabling

4. Insert the controller into the bottom snap joints of the back cover at an angle. See Figure 6.

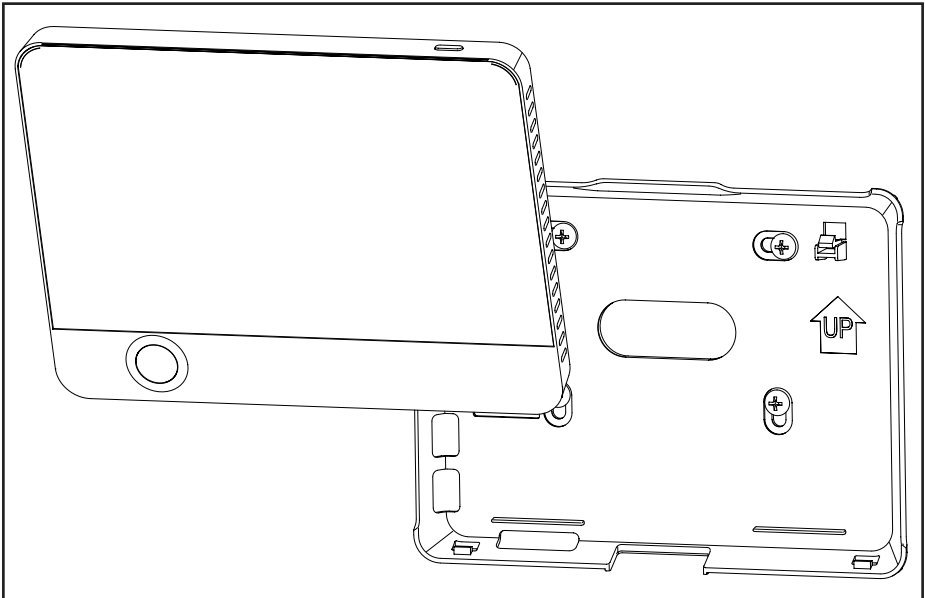

Figure 6. Insert Controller into Back Cover

5. Push the controller back toward the wall until it “snaps” into place. See Figure 7.

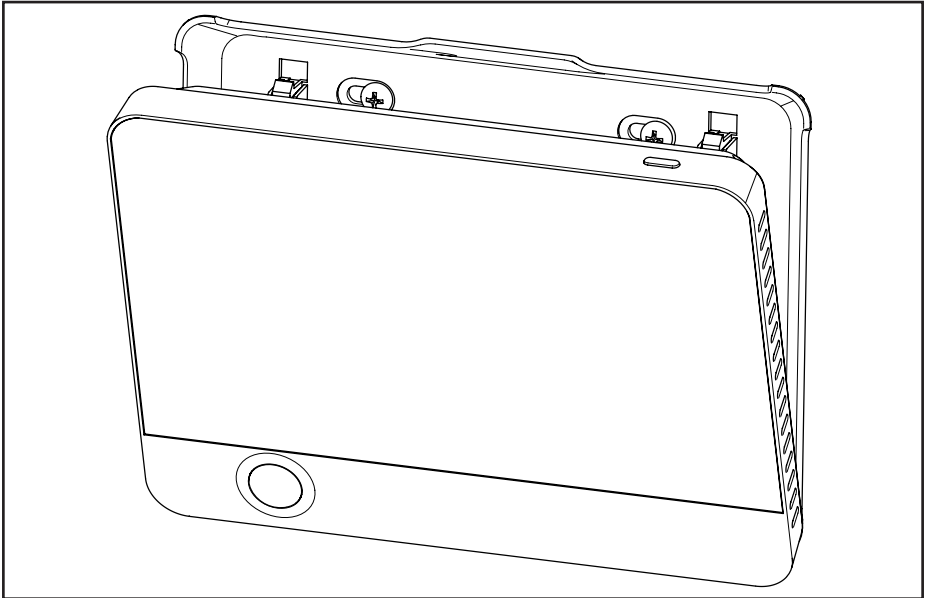

Figure 7. Snap Controller Into Place

Home Screen Display

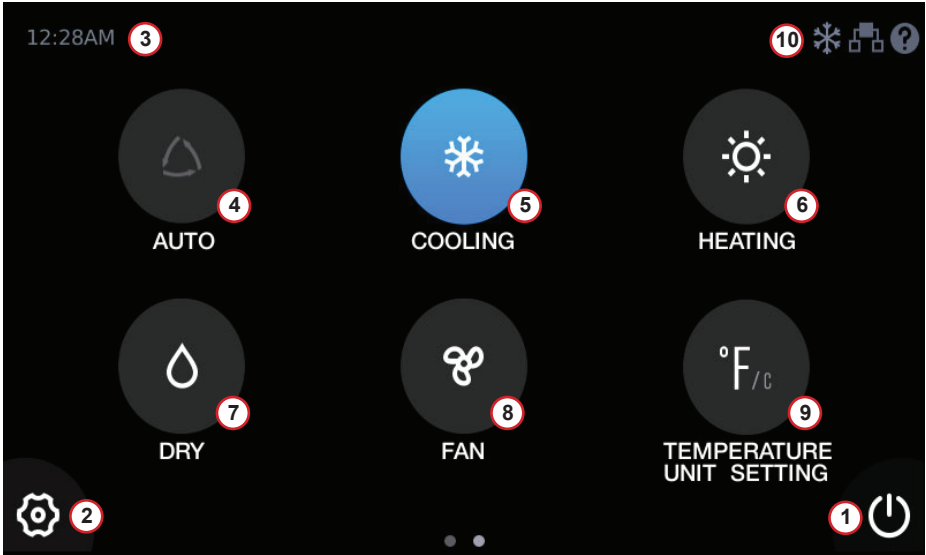

Figure 8. Home Screen Display 1

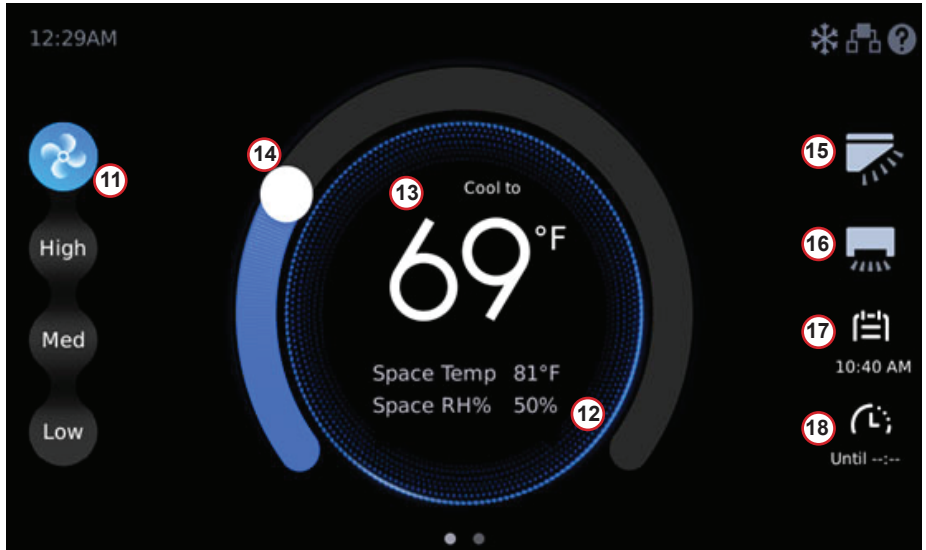























Figure 9. Home Screen Display 2

Table 1. Home Screen Display

Number	Display Item	Description
1	ON/OFF button	Tap to turn the indoor unit on or off.
2	Settings button	Tap to access the menu screen.
3	Time Display	Displays the current system time.
4	Auto Mode Settings	Select Auto mode when the indoor unit is ON, and then the indoor unit will run in Auto mode (the icon illuminates after selection).
5	Cooling Mode Settings	Select Cooling mode when the indoor unit is ON, and then the indoor unit will run in Cooling mode (the icon illuminates after selection).
6	Heating Mode Settings	Select Heating mode when the indoor unit is ON, and then the indoor unit will run in Heating mode (the icon illuminates after selection).
7	Dry Mode Settings	Select Dry mode when the indoor unit is ON, and then the indoor unit will run in Dry mode (the icon illuminates after selection).
8	Fan Mode Settings	Select Fan mode when the indoor unit is ON, and then the indoor unit will run in Fan mode (the icon illuminates after selection).
9	Temperature Unit Settings	Switch the temperature unit: display in Fahrenheit/Celsius temperature.
10	Operation Mode	Displays the mode of operation of the indoor unit.
11	Fan Speed Control Button	Select fan speed, and tap "Auto", "High", "Med", or "Low" to confirm the selection.
12	Indoor Temperature and Humidity Display	Display the temperature and humidity of the room in which the indoor unit is located.
13	Setpoint	Displays the setpoint.
14	Setpoint Adjustment Slider	Adjust the setpoint by pressing and sliding.
15	Vertical Swing Angle Display	Displays the vertical swing angle of the indoor unit; tap to access the vertical swing angle settings.
16	Horizontal Swing Position Display	Display the horizontal swing angle of the indoor unit; tap to enter the horizontal swing angle settings.
17	Weekly Schedule Display	Display the setting status of the weekly schedule status, and tap to access the weekly.
18	Override Status Display	Display the Override status and tap here to set the Override settings.

Table 2. Special Status Symbol Displays

No.	Icon	Name	Description
1		Fan	Displays when the indoor unit is in Fan mode.
2		Cool	Displays when the indoor unit is in Cooling mode.
3		Heat	Displays when the indoor unit is in Heating mode.
4		Dry	Displays when the indoor unit is in Dry mode.
5		Cooling operation in Auto mode	Displays when the indoor unit is in Auto mode providing cooling operation.
6		Heating operation in Auto mode	Displays when the indoor unit is in Auto mode providing heating operation.
7		Centralized controller lock	Displays when some functionality is locked by a centralized controller.
8		Group control	Displays when more than one indoor unit is connected to the controller.
9		Occupancy sensor	Displays when an occupancy sensor is active.
10		Help	Tap to see the Help screens.
11		Mode conflict prompt	Displays when the indoor unit is in mode conflict with the outdoor unit (heat pump systems)
12		Auto Dry function	Displays when auto dry function is ON.
13		Master controller	Displays if the controller is a master.
14		Master controller	Displays if the controller is a sub.
15		Outside air ducted indoor unit	Displays if the connected indoor unit is providing outside air.
16		ON/OFF lock	Displays when some functionality is locked by settings on this controller.
17		Mode lock	Displays when Mode is locked.

No.	Icon	Name	Description
18		Setpoint lock	Displays when Setpoint is locked.
19		Schedule lock	Displays when Schedule is locked.
20		Defrosting or oil return	Displays when the outdoor unit is in defrost or oil return operation.
20		Cold air prevention	Displays during period of time before the coil warms to the determined cold air prevention temperature. The fan will not run during this time period.

Operation

NOTE - Indoor units connected to a local controller may also be controlled by a centralized controller. Indoor units respond to the last command sent. It is recommended that indoor units be controlled from a single source of control, either local controller or centralized controller but not both, to avoid conflicts in commands.

ON/OFF

Tap the On/Off button to turn the indoor unit on or off.

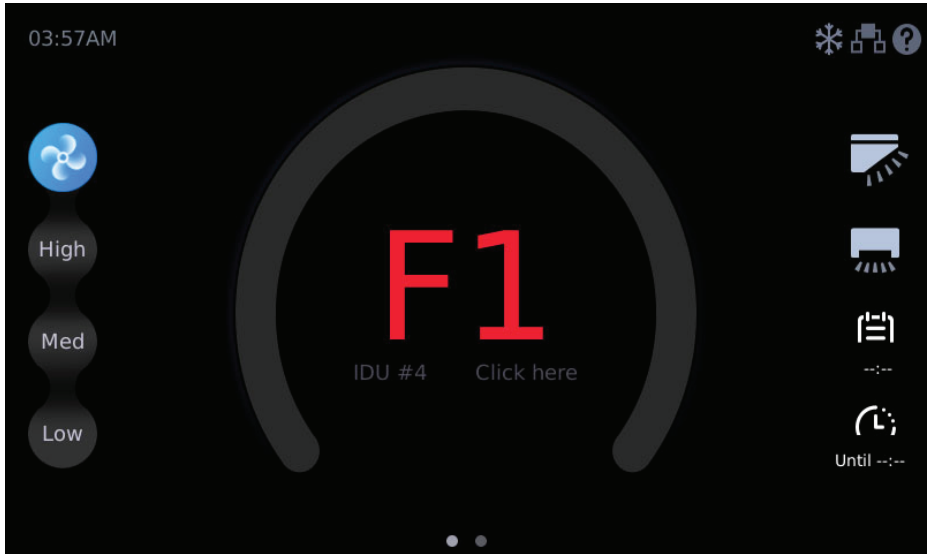

Figure 10. ON/OFF Operation

Error Code Display

When the connected indoor units or outdoor unit has an error, the original set temperature interface will display the error code.

Tap the error display area and to open the error code description interface.



Home < Help < Error Code	
Swing	Indoor Unit Error Code
Schedule	FE No address
Daylight Savings Time	E0 Mode conflict
Room Temperature&RH%	E1 Communication error between indoor and main outdoor unit
Advanced Information	E2 T1 (Room temperature sensor) malfunction
Contractor Information	E3 T2 (Middle of evaporator sensor) malfunction
Help	E4 T2B (Outlet of evaporator sensor) malfunction
Service Menu	E5 T2A (Inlet of evaporator sensor) malfunction
	E6 DC fan motor error
	E7 EEPROM failure
	Eb EEV malfunction
	Ed ODU Fault

Figure 11. Error Code Display

Mode Settings

Cooling Mode Operation

When the indoor unit is powered on, tap COOLING in the operating mode selection interface. The selected icon will illuminate when the indoor unit runs in Cooling mode. The Cooling icon is displayed in the upper right corner of the home page.

To adjust the setpoint, tap the setpoint slider and drag the slider to the new setpoint temperature. The default setpoint range is 62°F to 86°F (17°C to 30°C).

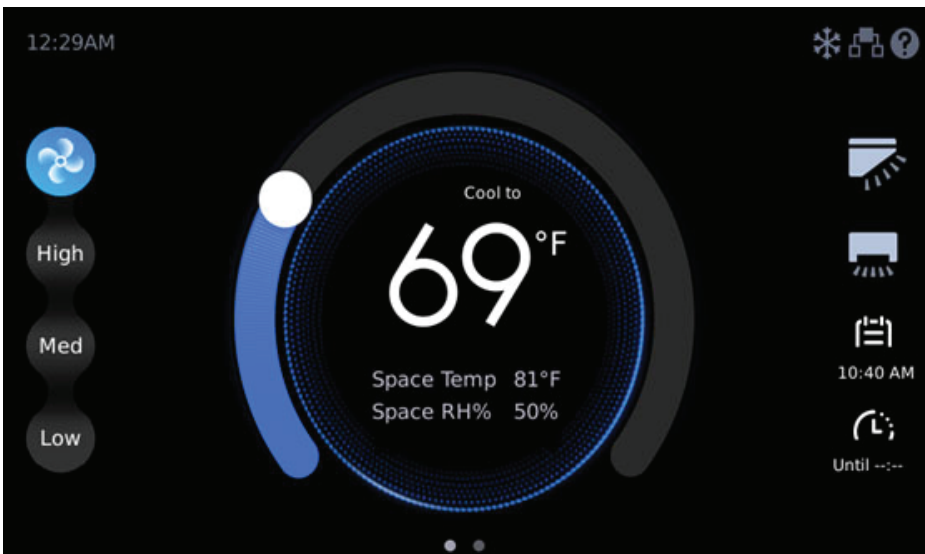
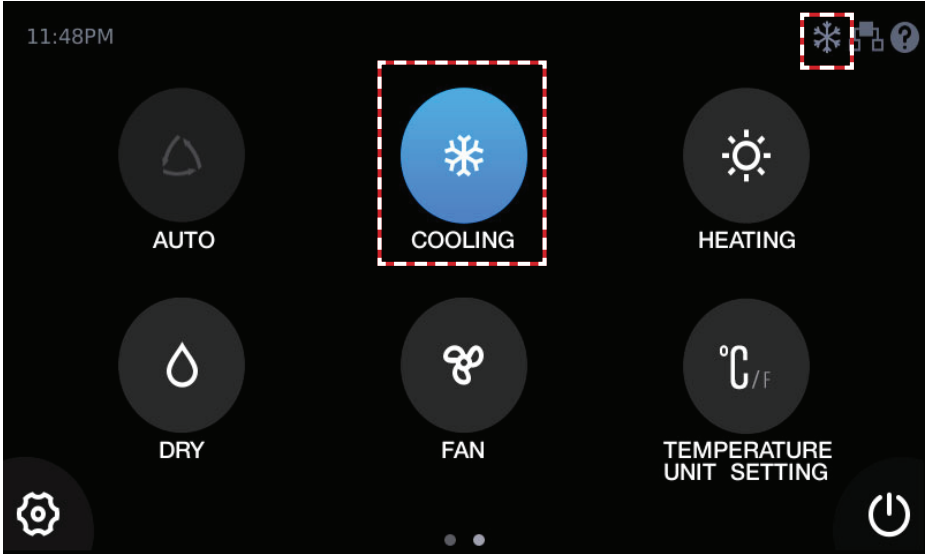

Figure 12. Cooling Mode Operation

Heating Mode Operation

When the indoor unit is powered on, tap HEATING in the operating mode selection interface. The selected icon will illuminate when the indoor unit runs in Heating mode. The Heating icon is displayed in the upper right corner of the home page.

To adjust the setpoint, tap the setpoint slider and drag the slider to the new setpoint temperature. The default setpoint range is 62°F to 86°F (17°C to 30°C).

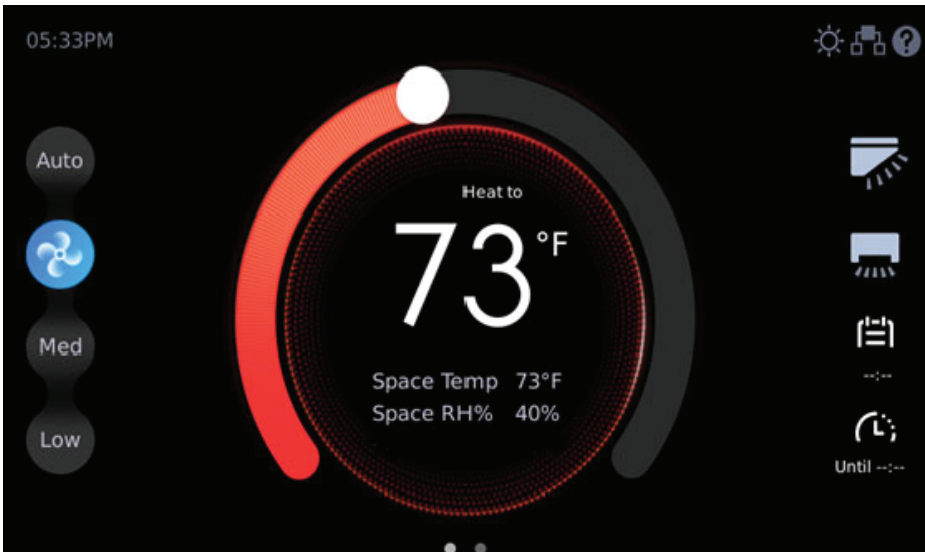
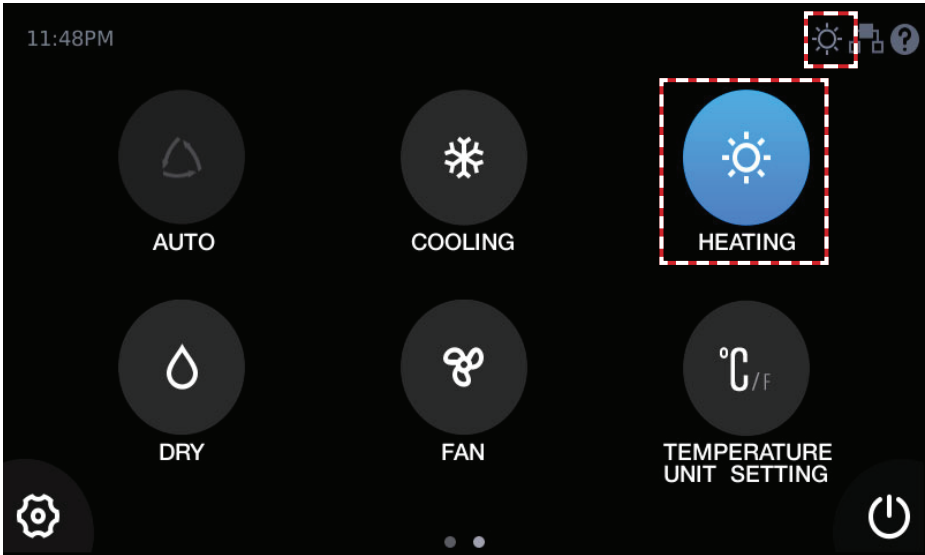

Figure 13. Heating Mode Operation

Auto Mode Operation

When the indoor unit is powered on, tap AUTO in the operating mode selection interface. The selected icon will illuminate when the indoor unit runs in Auto mode. The Auto icon or the Cooling icon is displayed in the upper right corner of the home page.

NOTE - During Auto mode, both operation mode (cooling or heating) setpoints display on the Home screen. **The current operation mode setpoint displays larger than the non-current operation mode.**

In Auto mode the Cooling setpoint range is 68°F to 86°F (20°C to 30°C), the Heating setpoint range is 62°F to 81°F (17°C to 27°C).

To adjust the setpoint of either cooling or heating while in Auto mode, tap the appropriate setpoint, either cooling or heating. That setpoint will display as the larger number. Drag the temperature slider to the new setpoint temperature. If the setpoint you adjusted is not the current operation mode, after 10 seconds, the current operation mode setpoint will display as the larger number.

NOTE - The setpoint deadband between cooling and heating setpoints is setup in the Settings menu.

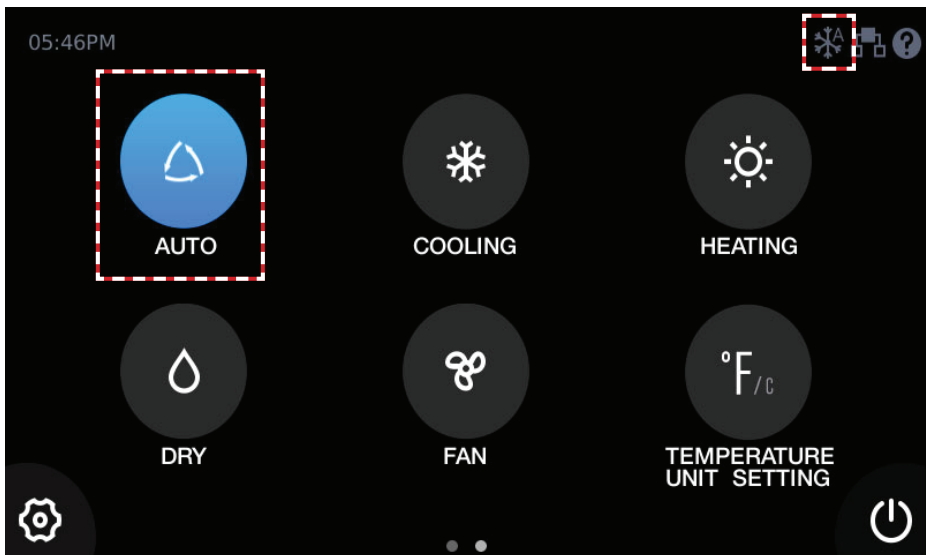

Figure 14. Auto Mode Operation

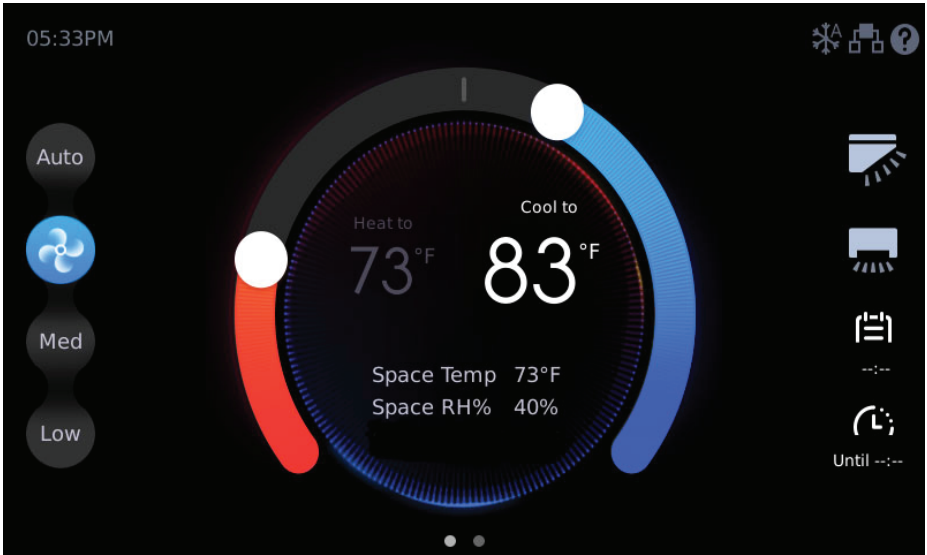

Figure 15. Auto Mode Setpoints

Dry Mode Operation

When the indoor unit is powered on, tap DRY in the operating mode selection interface. The selected icon will illuminate when the indoor unit runs in Dry mode. The Dry icon is displayed in the upper right corner of the home page.

Fan speed cannot be adjusted during Dry mode.

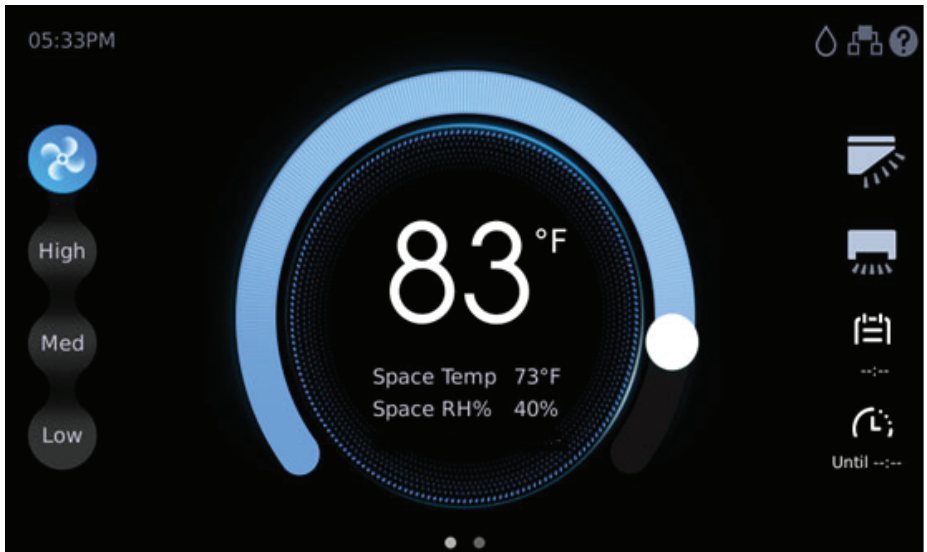
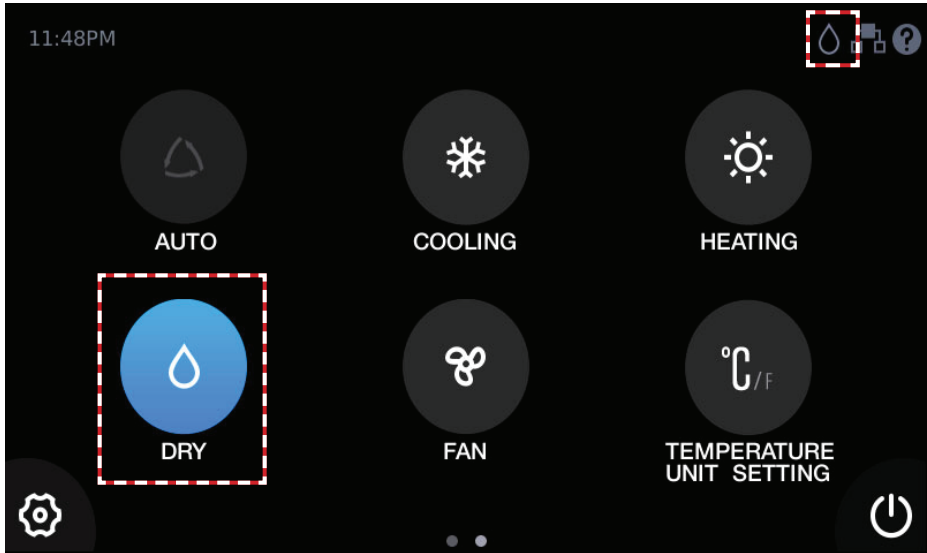

Figure 16. Dry Mode Operation

Fan-Only Operation

When the indoor unit is powered on, tap FAN in the operating mode selection interface. The selected icon will illuminate when the indoor unit runs in Fan mode. The Fan icon is displayed in the upper right corner of the home page.

The indoor unit fan operates without heating or cooling.

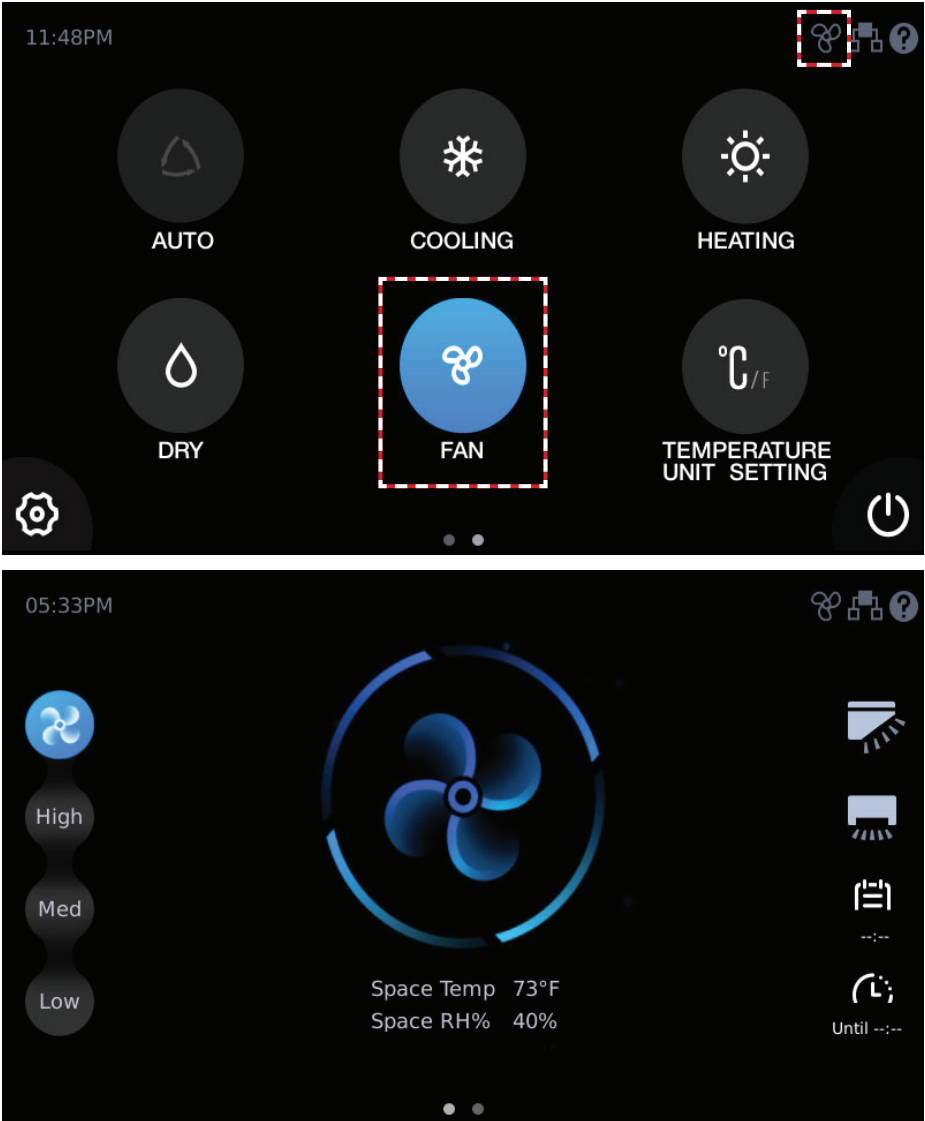

Figure 17. Fan-Only Mode Operation

Temperature Setpoint

To adjust the setpoint, tap the setpoint slider and drag the slider to the new setpoint temperature. The default setpoint range is 62°F to 86°F (17°C to 30°C). The setpoint range can be adjusted using the Setpoint Limit screen in the Service menu.

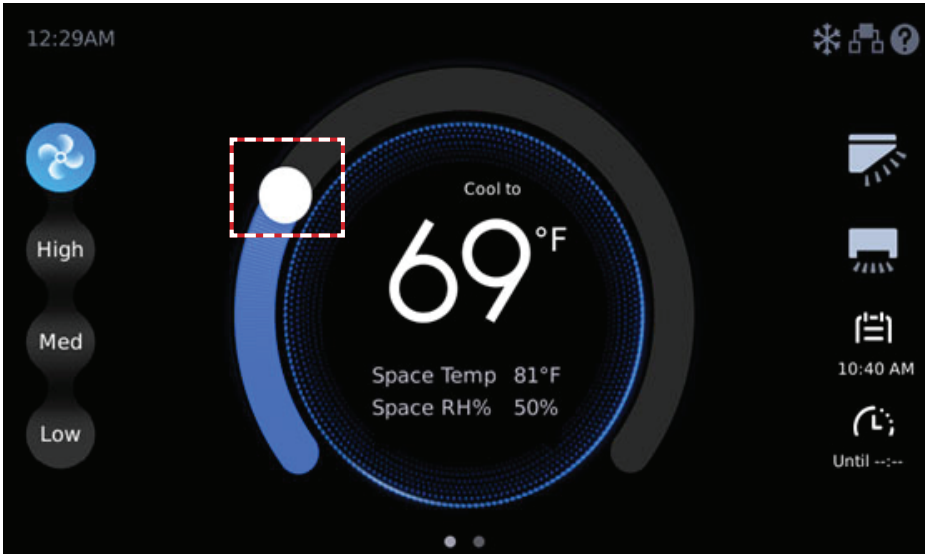

Figure 18. Temperature Setpoint

Space Temperature and Space Humidity Display

On the main screen of the controller, you can view the current setpoint, space temperature and space humidity.

When the master wired controller chooses the Follow function, the Space Temp will display the temperature and corrected value detected by the temperature sensor of the master wired controller itself.

When the master and Sub wired controllers do not choose the Follow function, their Space Temp will display the temperature detected by their own temperature sensors (without a corrected value).

The temperature sampling range is -16°F to 156°F (-9°C to 70°C). The humidity sampling range is 0% to 100%.

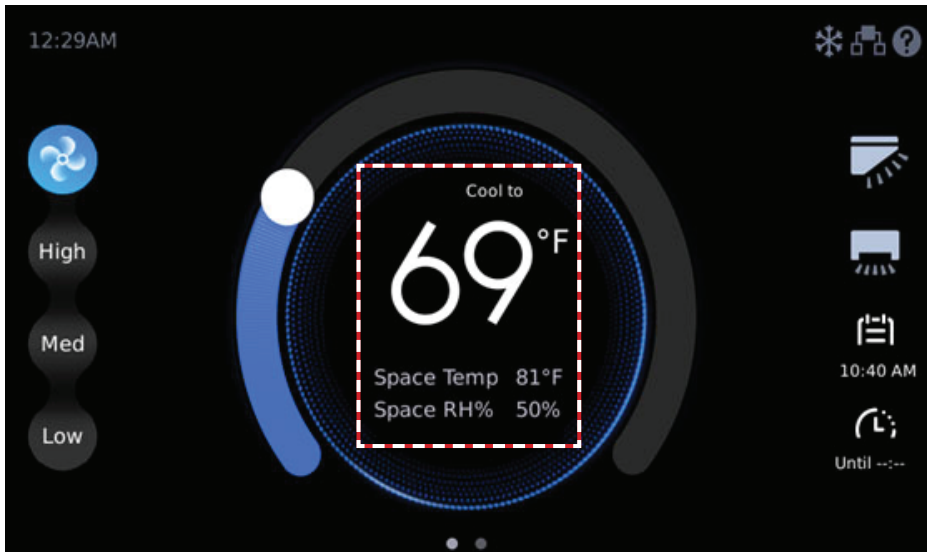

Figure 19. Setpoint, Space Temperature & Space Humidity Display

Temperature Unit Switching (°F/°C)

Tap TEMPERATURE UNIT SETTING at the lower right corner to switch the temperature display unit between Fahrenheit and Celsius.

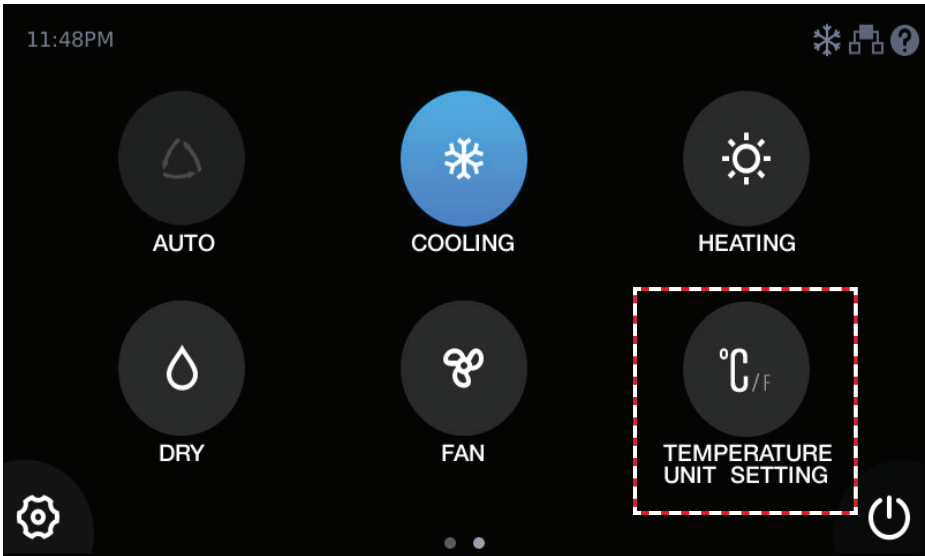

Figure 20. Fahrenheit or Celsius Temperature Display

Fan Speed

Tap Auto, High, Med, or Low to change the fan speed. The corresponding icon illuminates after selection.

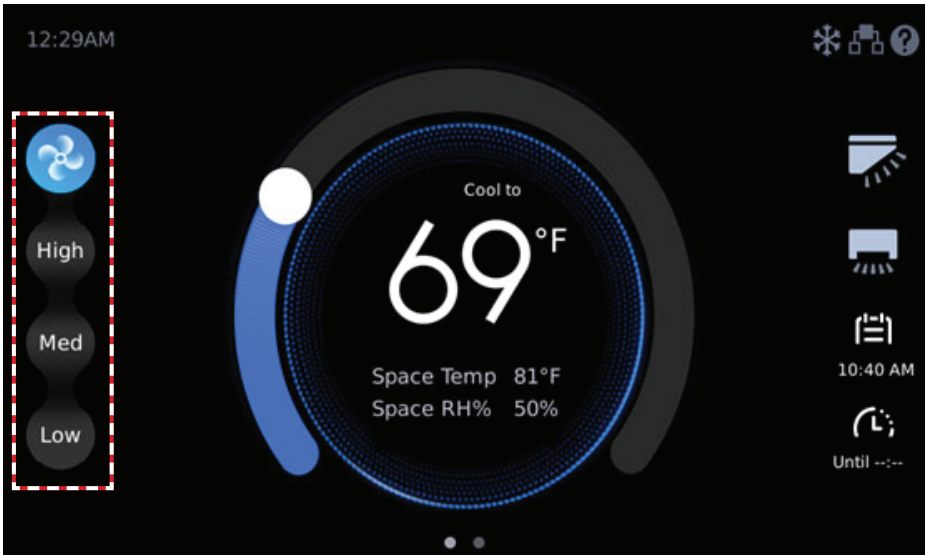

Figure 21. Fan Speed Operation

Swing

Tap the Vertical Swing Angle Settings icon and the Horizontal Swing Angle Settings icon to enter the swing angle settings interface.

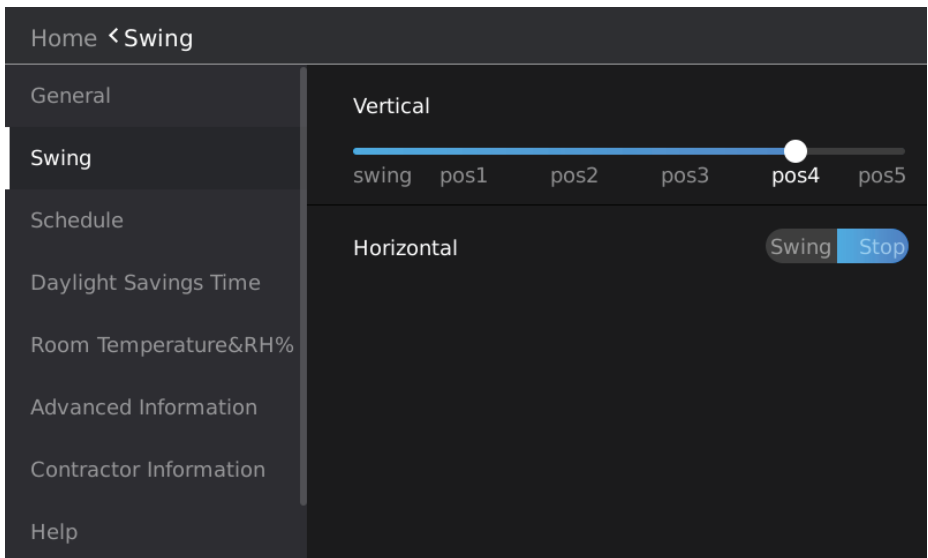
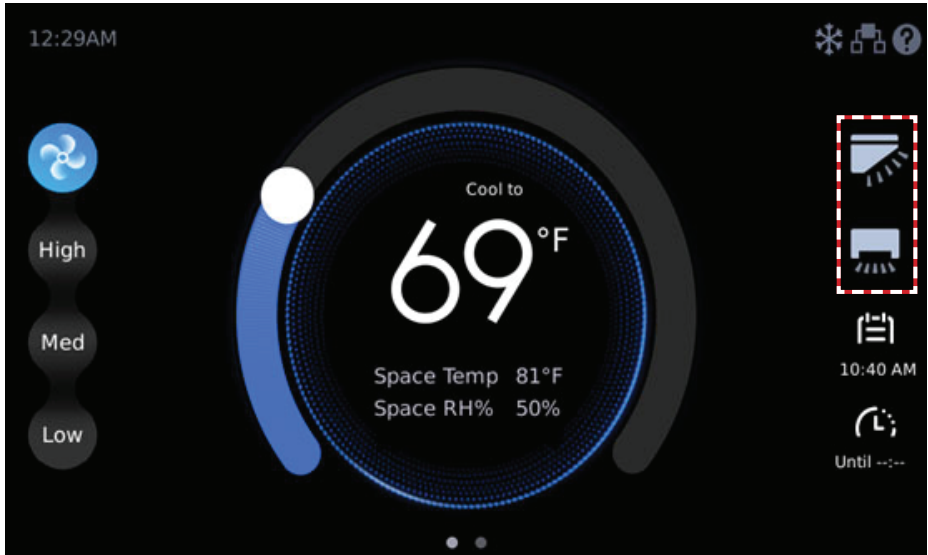

Figure 22. Swing Settings

Weekly Schedule Settings Quick Access

Tap the Weekly Schedule Settings icon to enter the weekly schedule settings interface.

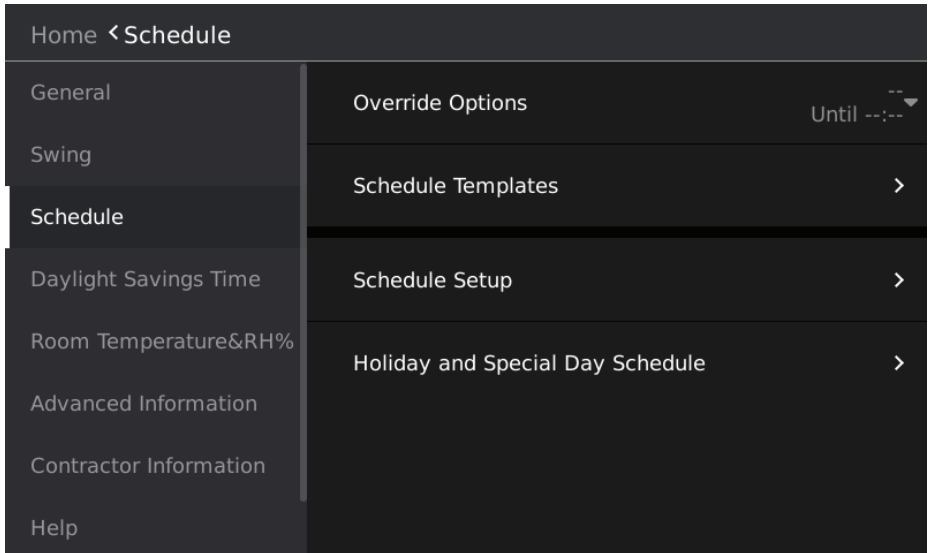
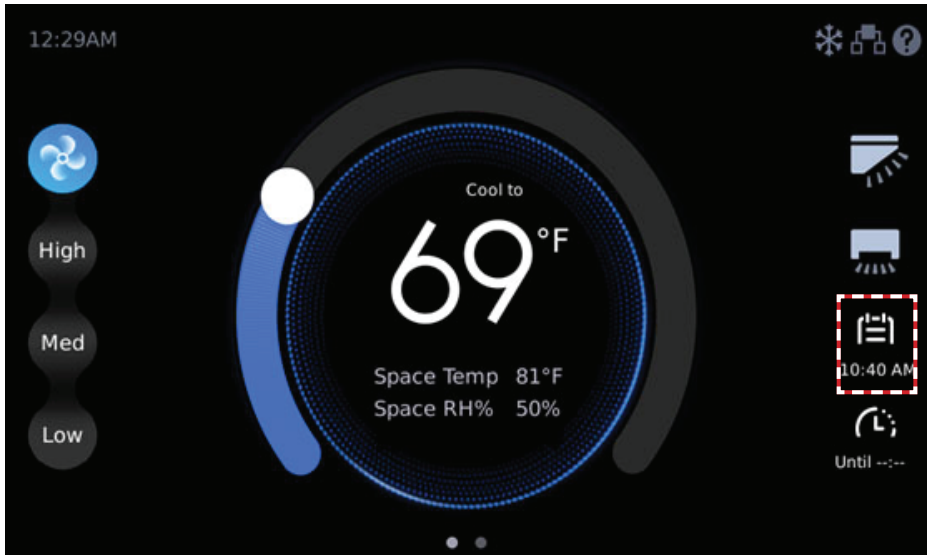

Figure 23. Quick Access to Weekly Schedule Settings

Override Settings

Tap the Override icon and the Override delay time selection box displays.

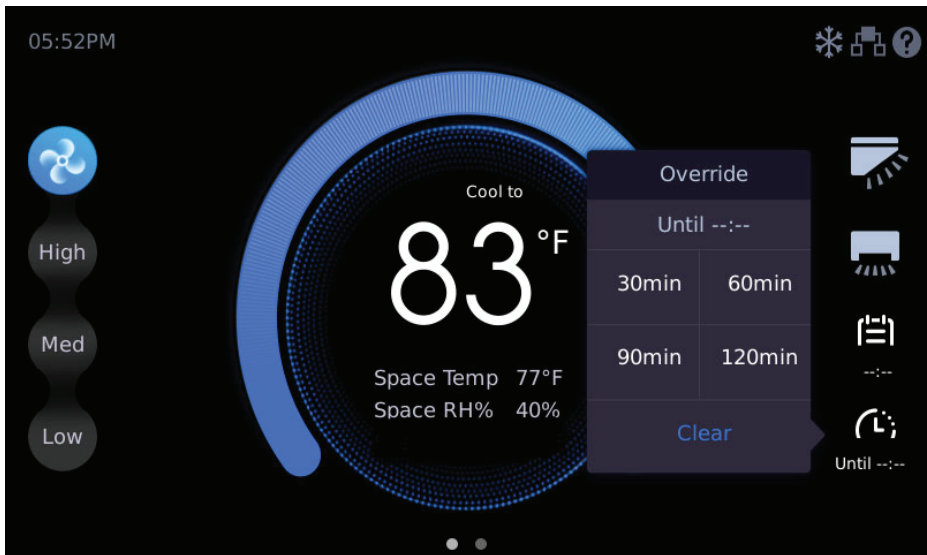
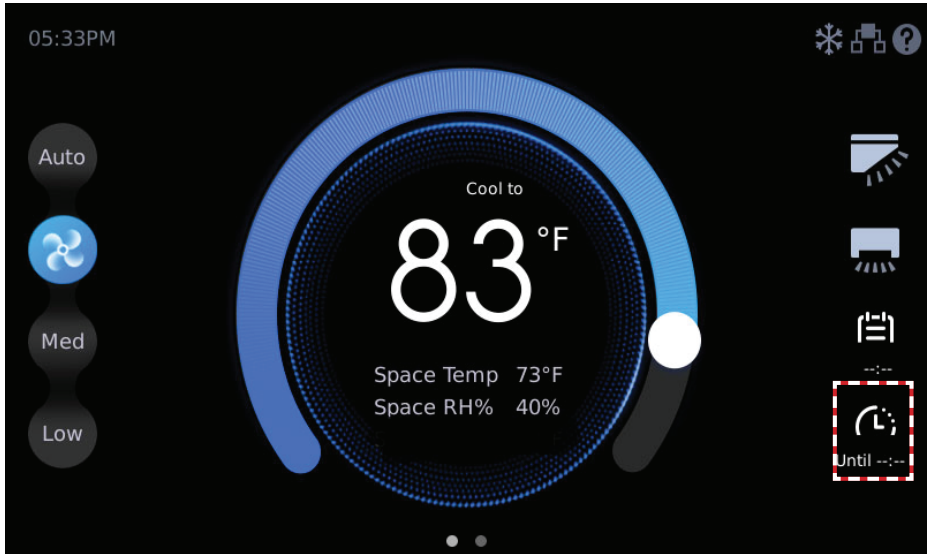

Figure 24. Override Settings

Schedule Management

NOTE – If schedules are used and a centralized controller is installed on the system, controller functions should not be locked from the centralized controller.

Tap the Schedule button to access the schedule management settings interface.

Set by week, and run different set statuses at different times of the day.

Before setting Schedule Templates, Schedule Setup, and Holiday and Special Day Schedule, you must first complete the date and time settings.

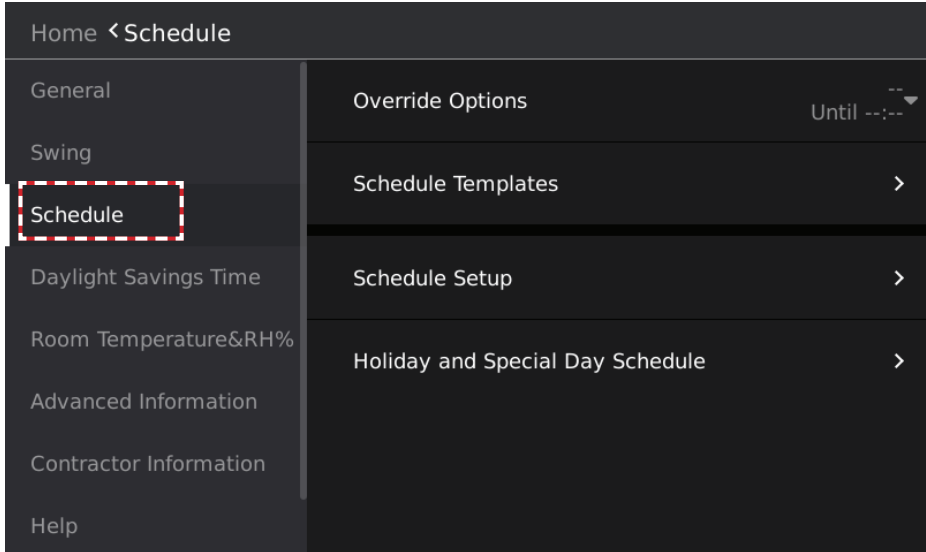

Figure 25. Tap Schedule Button to access Schedule Settings

If the system time is detected to be earlier than 01:00 AM Dec 30, 2017 (the factory default time is 2017-12-30), the setting date and time box will display. Tap “YES” to open to the date and time settings screen, or tap “NO” to return to the previous page.

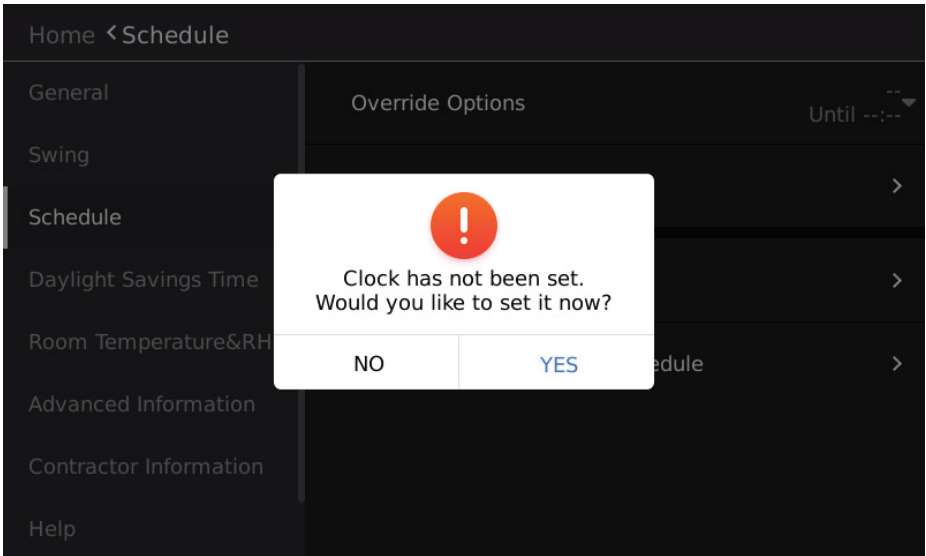

Figure 26. Set System Date & time

Setup Schedule Templates

Create a scheduled day's events. Tap the Schedule Templates button to access the daily schedule template settings interface.

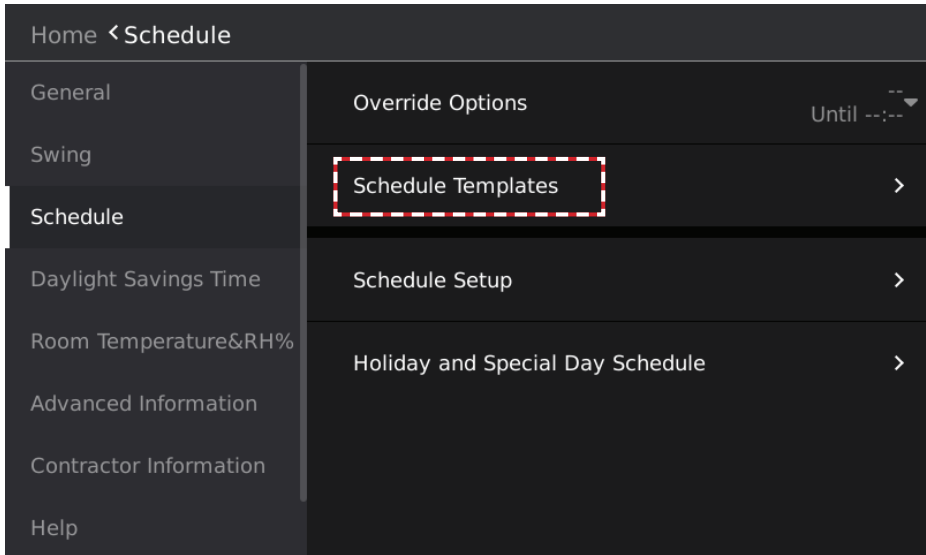

Figure 27. Tap Schedule Templates Button

Tap the Add button to add a daily schedule template. Up to 10 templates.

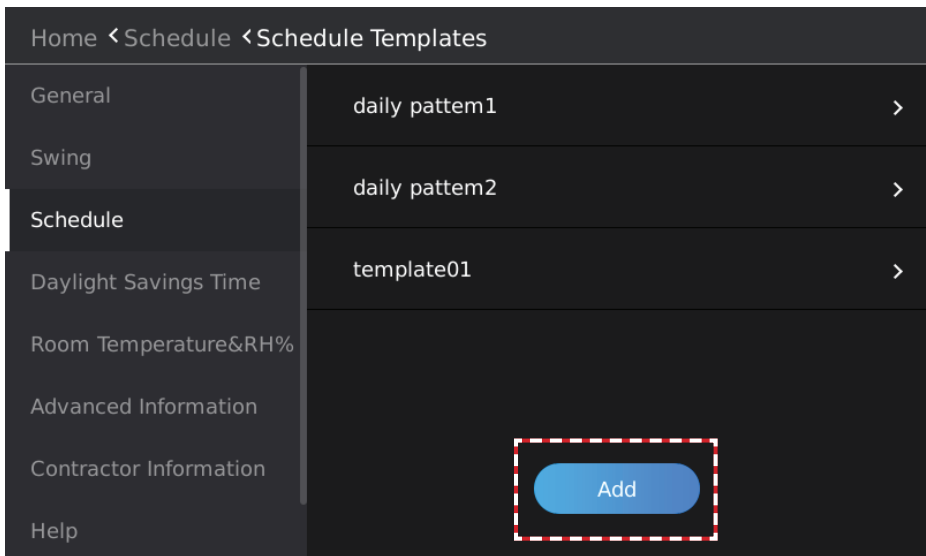

Figure 28. Add Daily Template

Copy and Paste a Schedule Template

Use the Copy and Paste buttons to copy a template and use it to create a new daily template.

Copy a Schedule

Press and hold the schedule template you want to copy. The Copy and Paste buttons will display. Tap the Copy button.

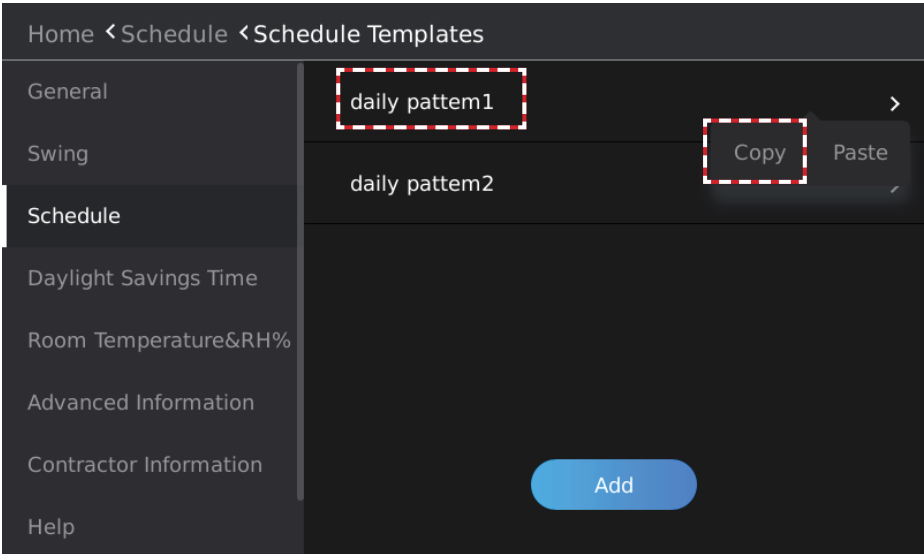

Figure 29. Copy a Schedule Template

Paste a Schedule

After copying a scheduled template, tap the Paste button.

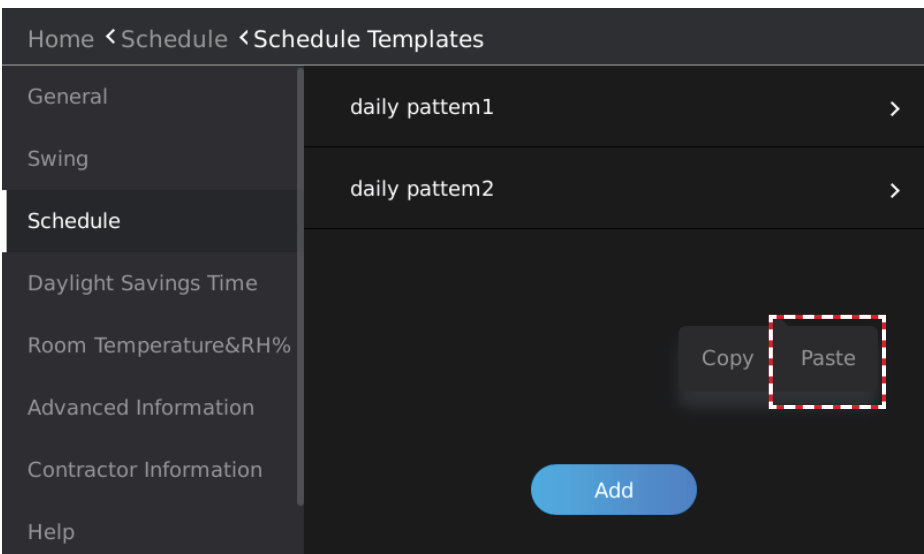

Figure 30. Paste to Create a New Schedule Template

The new schedule template will display. Rename the template as needed.

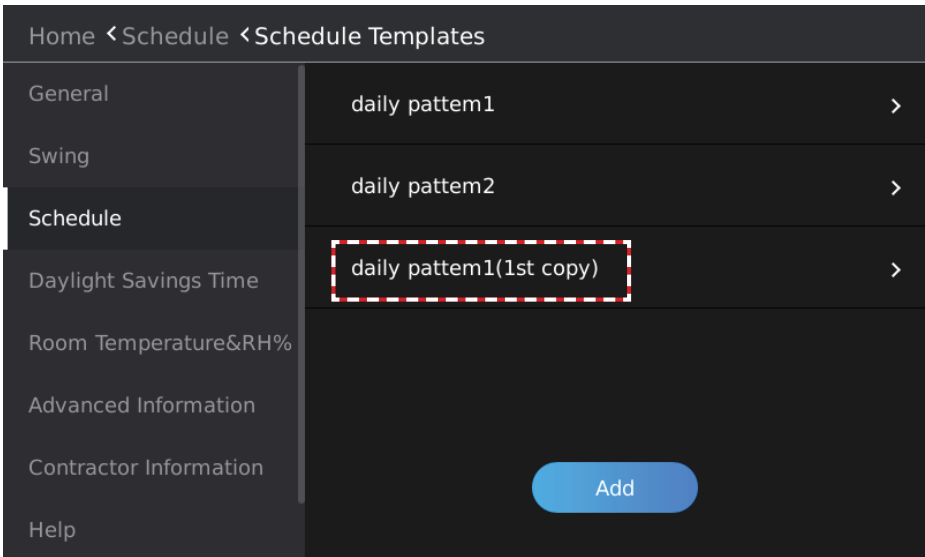

Figure 31. New Schedule Template

Rename a Schedule Template

Slide the daily schedule template to be deleted from the right to left, and “Rename” and “Delete” boxes will display. Tap Rename and enter the new name in the Edit box. Tap Yes to confirm. Tap Cancel to return to the previous screen.

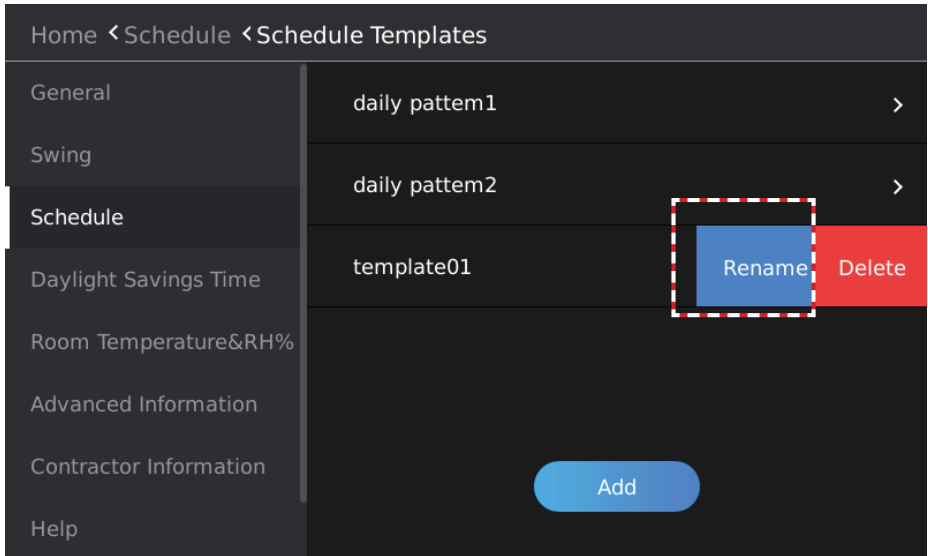

Figure 32. Rename a Schedule Template

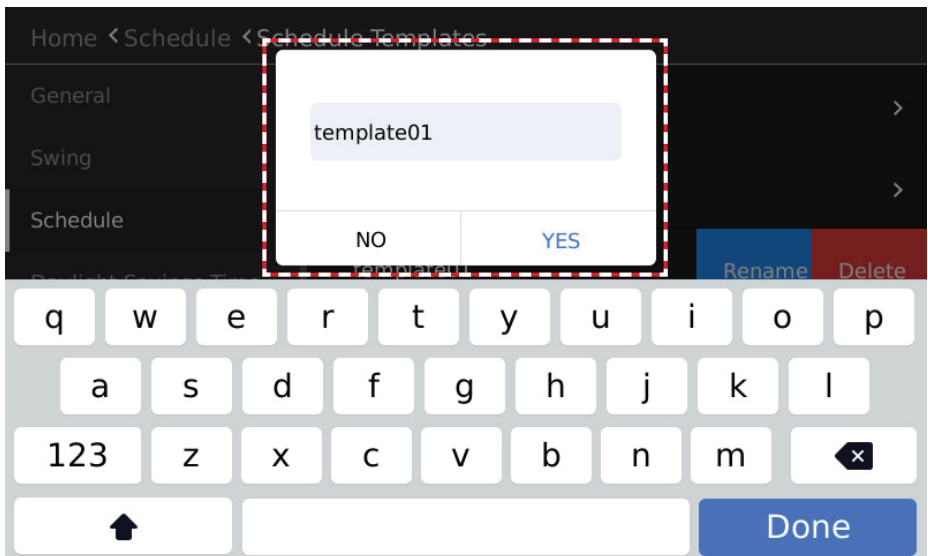

Figure 33. Enter Schedule Template Name

Delete a Schedule Template

Slide the daily schedule template to be deleted from the right to left, and “Rename” and “Delete” boxes will display. Tap Delete and Tap Yes when prompted. Tap Cancel to return to the previous screen.

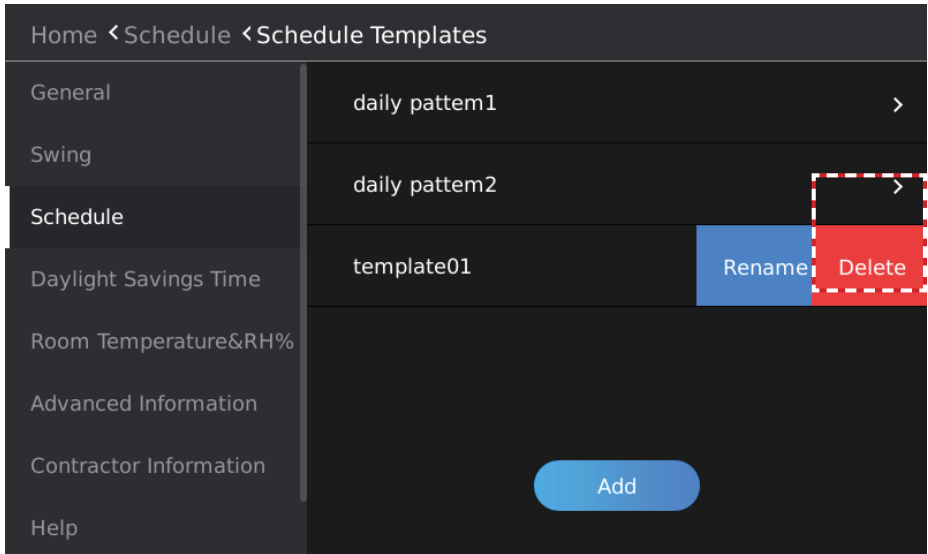

Figure 34. Delete a Schedule Template

Add a Daily Schedule Action

Tap the template to add the action to. Maximum of 8 actions per daily schedule template. The Action setup screen will display. Select the Action's Start Time, ON/OFF status, Operation Mode, Cooling Setpoint, Heating Setpoint and Fan speed. Each action will end at the Start time of the next action.

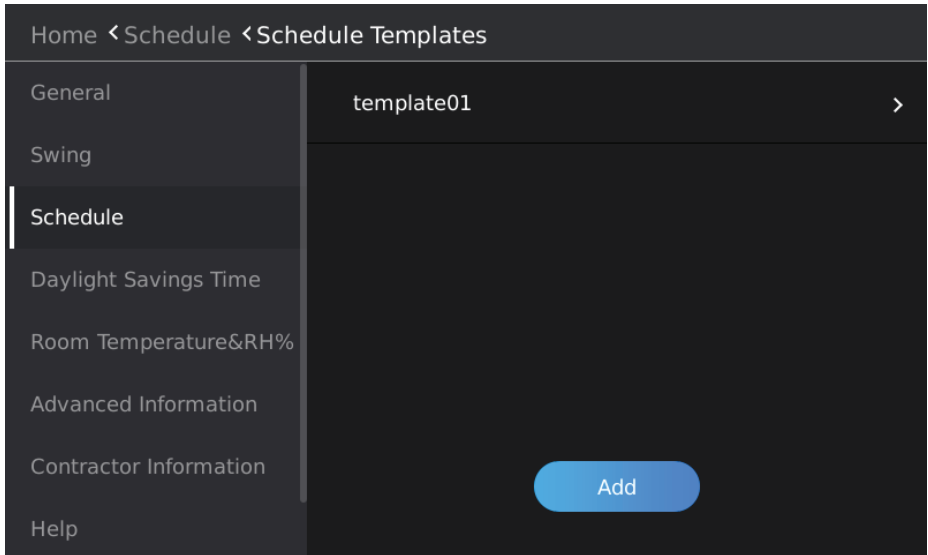

Figure 35. Add a Daily Schedule Action

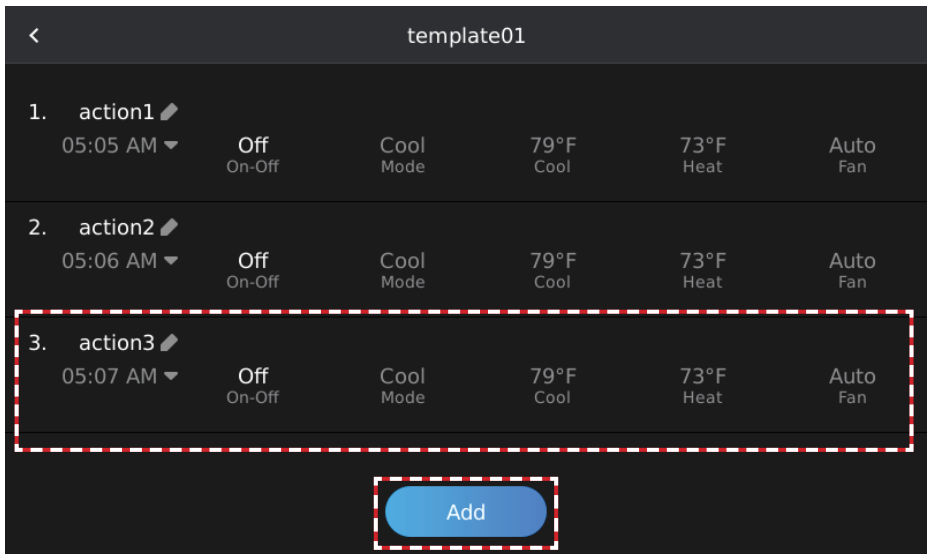

Figure 36. Setup Daily Schedule Action

Delete a Daily Schedule Action

Slide the daily schedule action that needs to be deleted from right to left, and the Delete box will display.

Tap Delete to delete the daily schedule action.

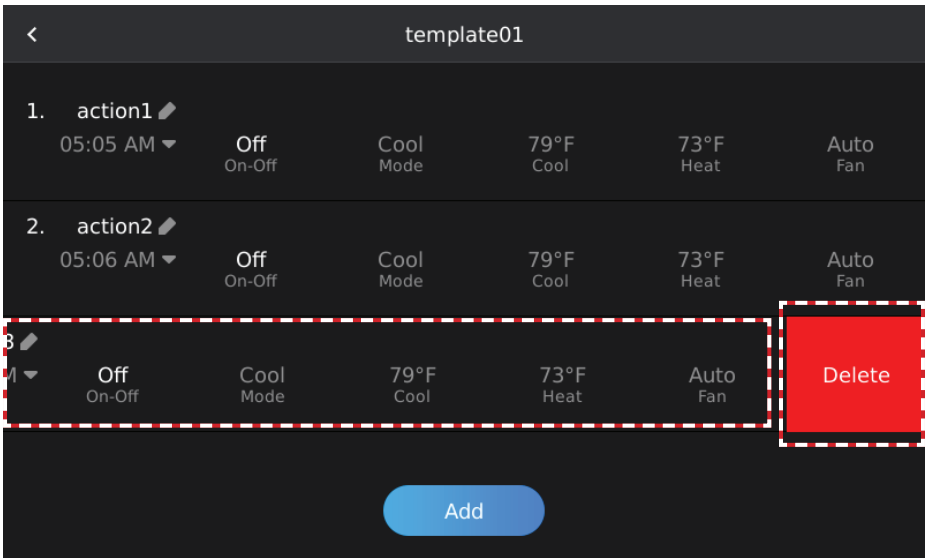

Figure 37. Delete Daily Schedule Action

Rename a Daily Schedule Action

Tap the Edit button on the right of the action to rename the event.

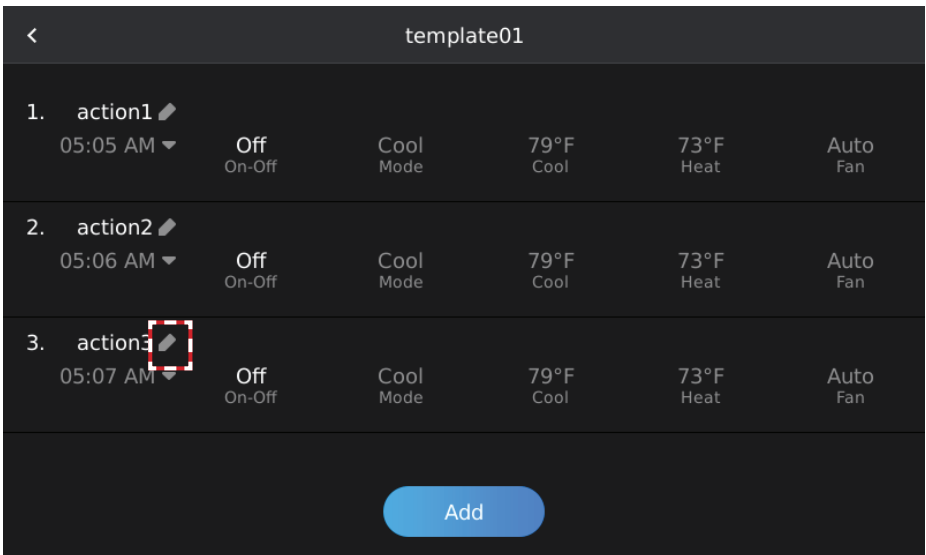

Figure 38. Rename a Daily Schedule Action

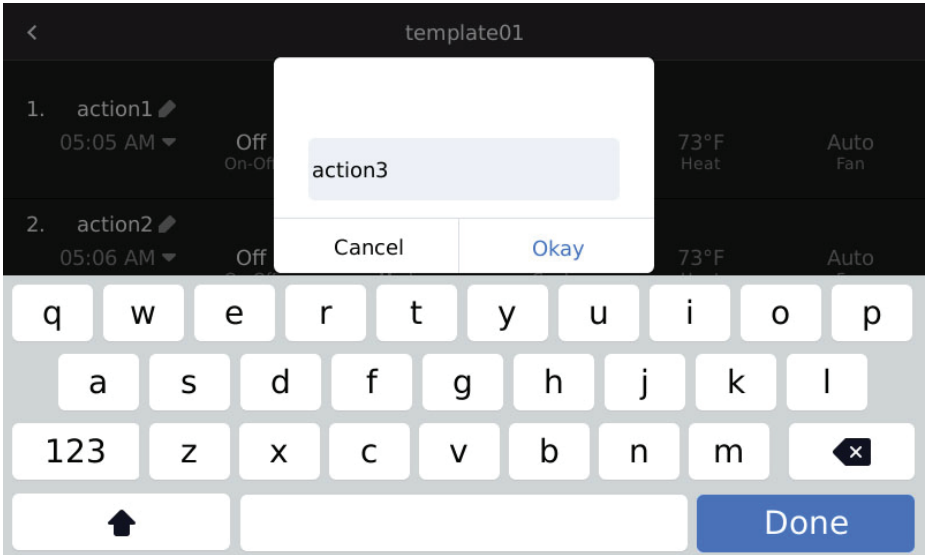

Figure 39. Rename a Daily Schedule Action Edit Box

Edit a Daily Schedule Action

Tap the daily schedule action content (e.g., time) that needs to be modified, and enter the daily schedule action content editing mode.

Slide up/down to increase/decrease the value and modify the daily schedule action content. The highlighted value in the middle is the currently set parameter.

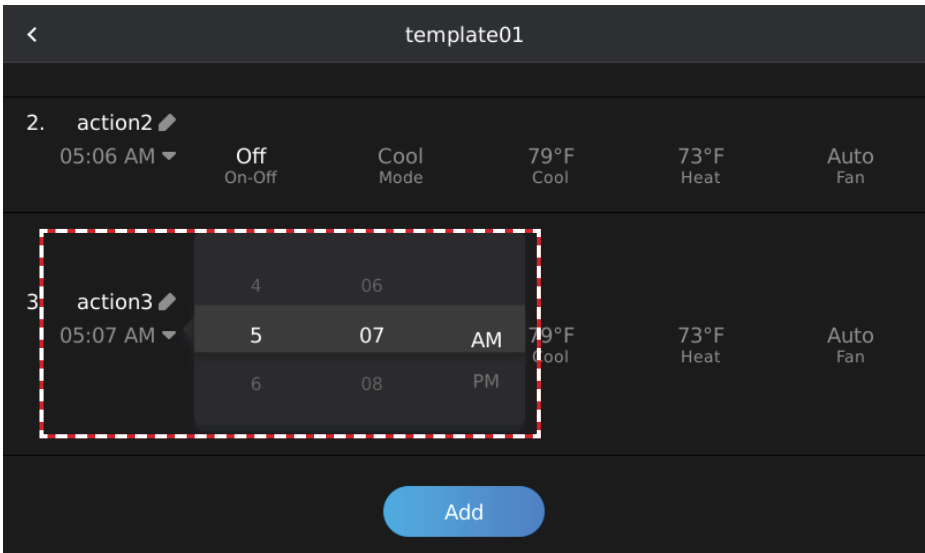

Figure 40. Modify a Daily Schedule Action

Setup a Weekly Schedule

Create a Weekly Schedule. Tap the Schedule button to access the schedule management settings interface.

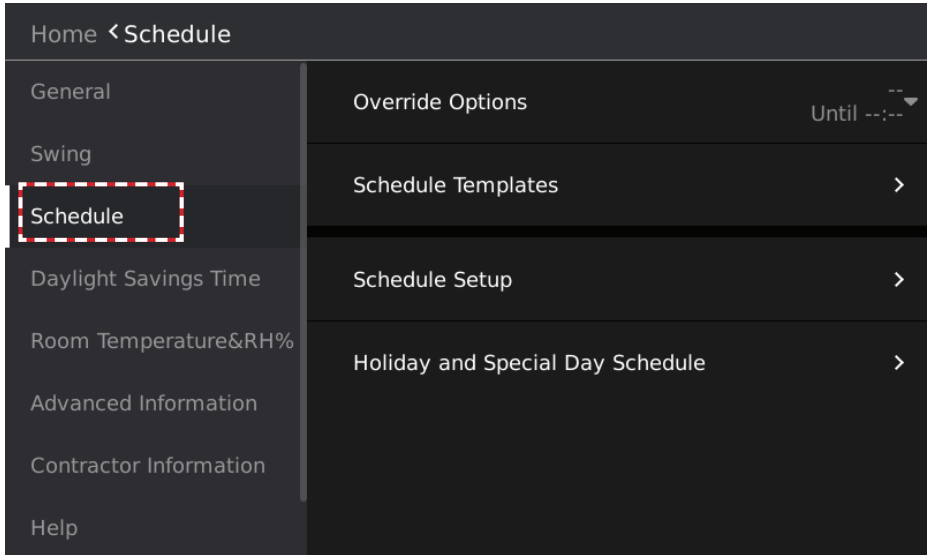

Figure 41. Tap Schedule Button to Access Schedule Settings

Tap the Schedule Setup button. The Schedule Setup screen will display.

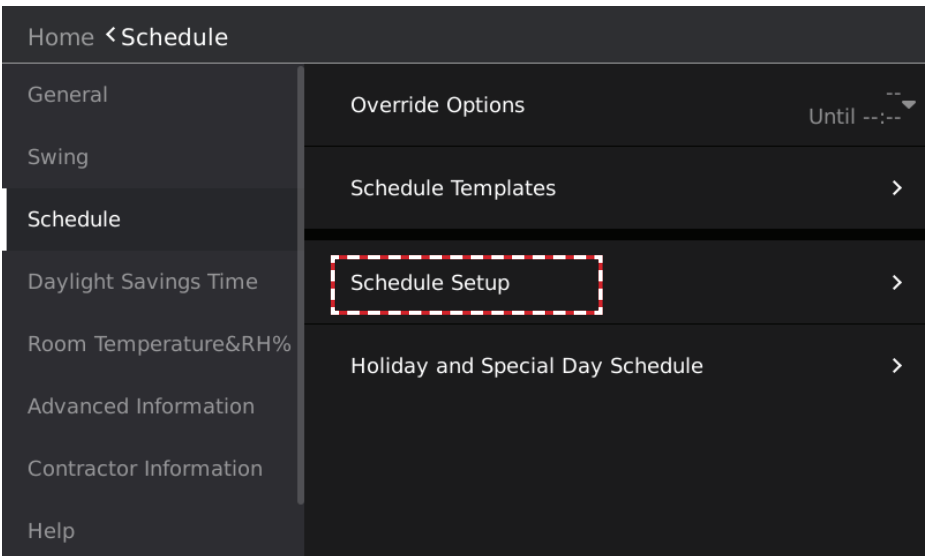

Figure 42. Tap Schedule Setup Button

Tap the Add button.

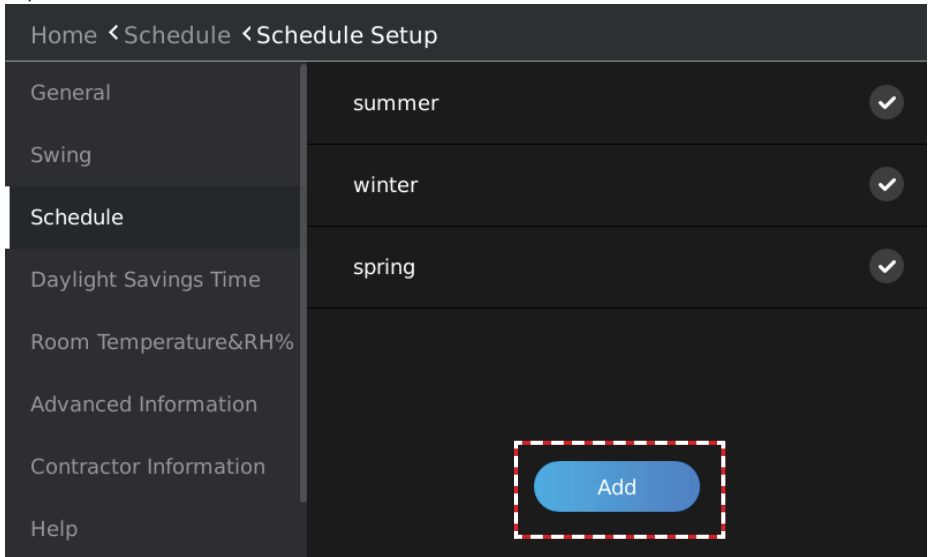

Figure43. Add a New Weekly Schedule

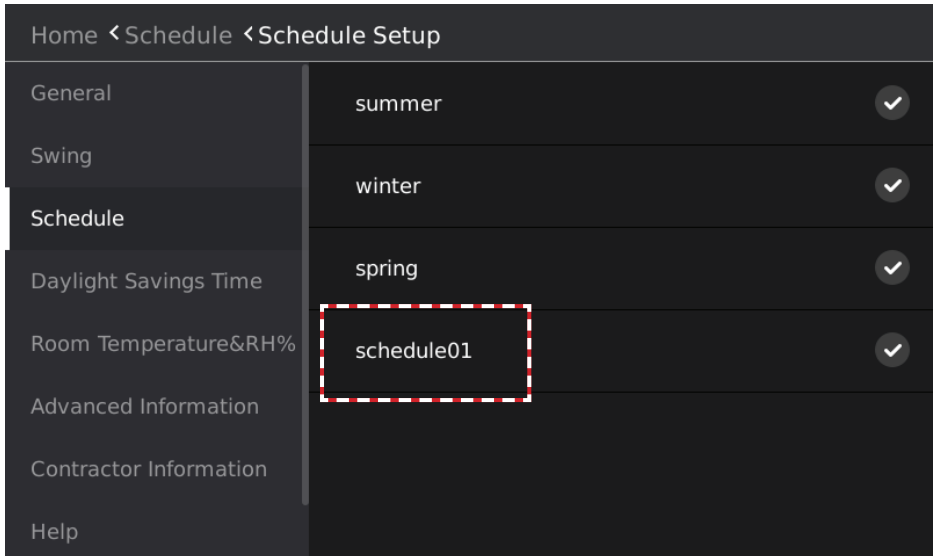

Figure 44. New Weekly Schedule

Rename a Weekly Schedule

Slide the weekly schedule to be deleted from the right to left, and “Rename” and “Delete” boxes will display. Tap Rename and enter the new name in the Edit box. Tap Yes to confirm. Tap Cancel to return to the previous screen.

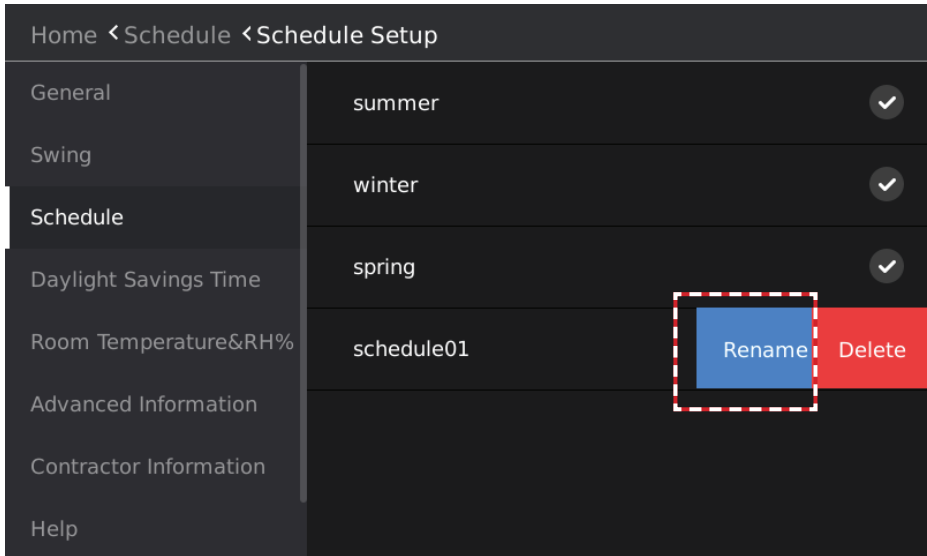

Figure 45. Rename a Weekly Schedule

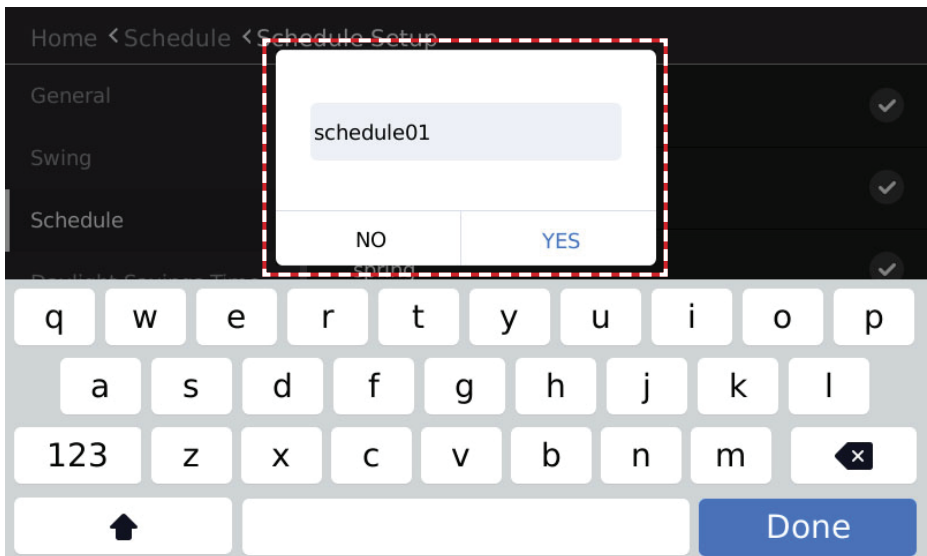

Figure 46. Enter Weekly Schedule Name

Delete a Weekly Schedule

Slide the weekly schedule to be deleted from the right to left, and “Rename” and “Delete” boxes will display. Tap Delete and Tap Yes when prompted. Tap Cancel to return to the previous screen.

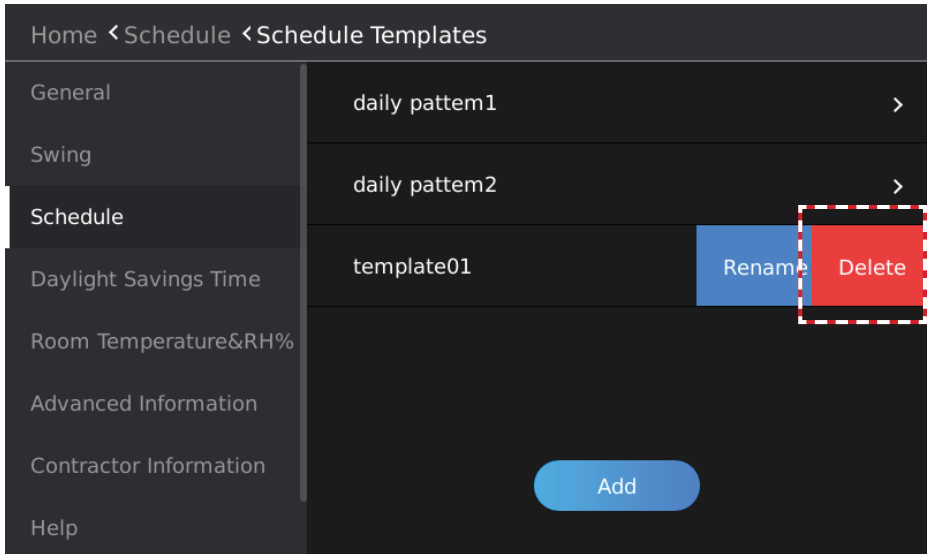

Figure 47. Delete a Schedule Template

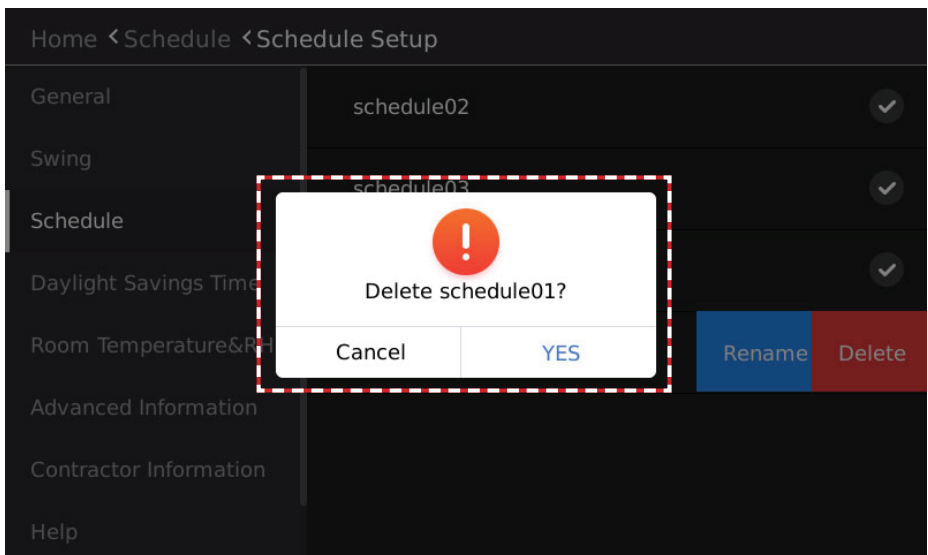

Figure 47. Confirm Deletion

Modify a Weekly Schedule

Enter the weekly schedule template content editing interface.

Tap the drop-down button on the right of “Everyday” and select the weekly schedule combination mode.

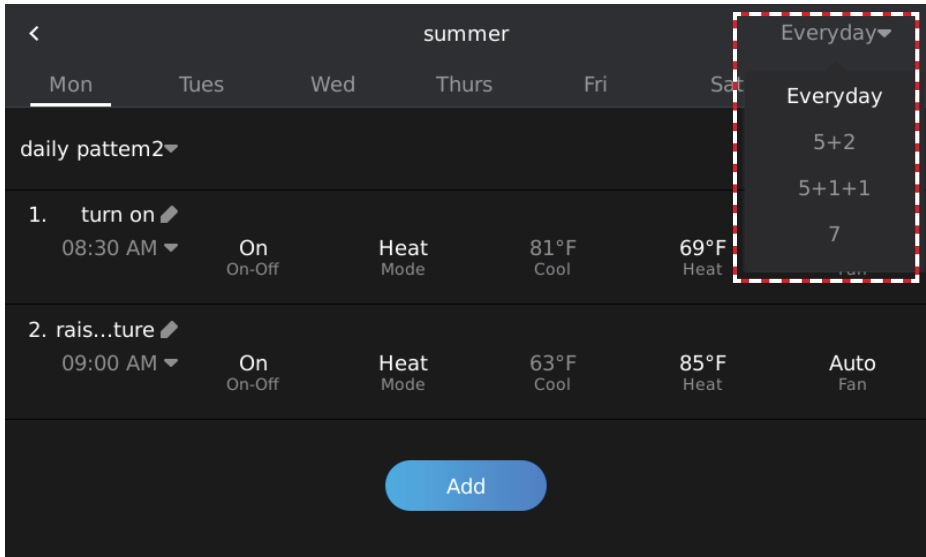

Figure 49. Modify a Weekly Schedule

Table 3. Schedule Options

Schedule	Description
Everyday	Set the schedule independently for each day of the week.
5+1+1	Set the schedule uniformly for Monday through Friday and independently for Saturday and Sunday.
5+2	Set the schedule uniformly for Monday through Friday and uniformly for Saturday and Sunday.
7	Set the schedule uniformly for each day of the week.

Tap the “daily pattern2” drop-down button to import the desired daily schedule template.

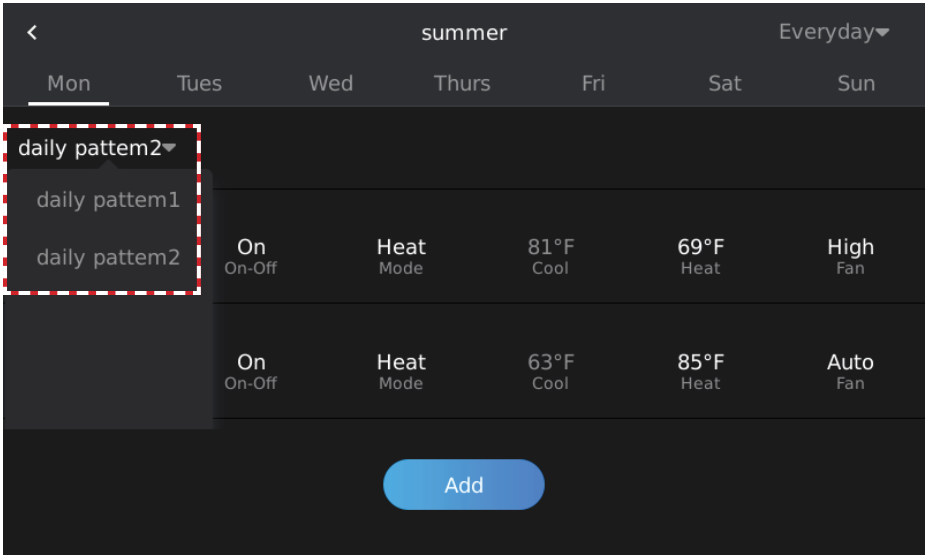
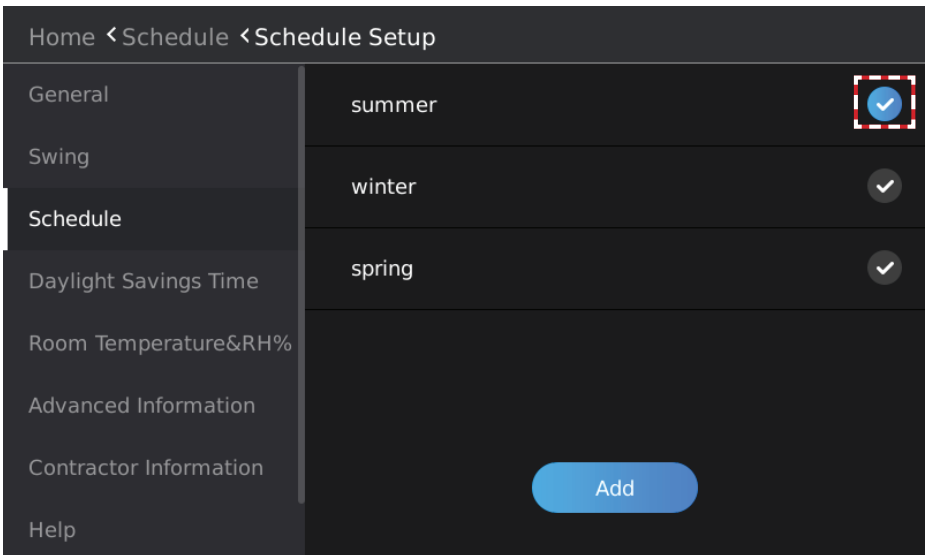

Figure 50. Select Daily Schedule Templates to Include in the Weekly Schedule

Select the Weekly Schedule to Use

Tap the button on the right of the weekly schedule template you want to select to complete the weekly schedule selection. The selected icon is highlighted after selection.



Setup Holiday and Special Day Schedules

Create a special schedule for holidays. Tap the Schedule button to access the schedule management settings interface.

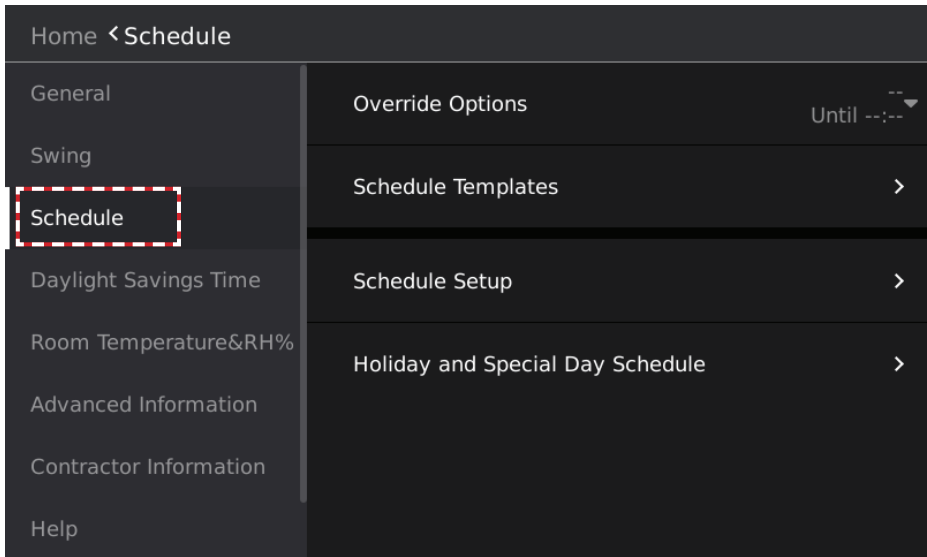

Figure 51. Tap Schedule Button to Access Schedule Settings

Tap the Holiday and Special Day Schedule button. The Holiday and Special Day Schedule screen will display.

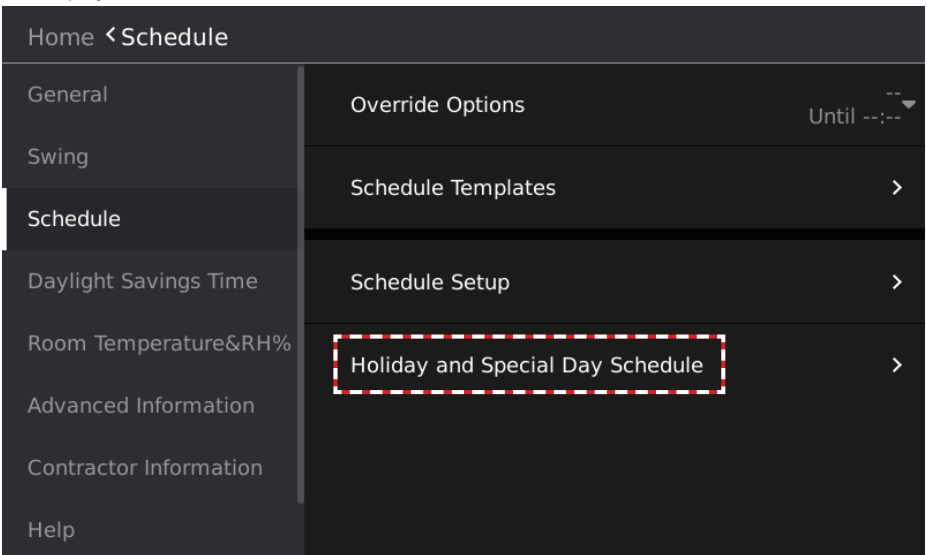

Figure 52. Tap Schedule Setup Button

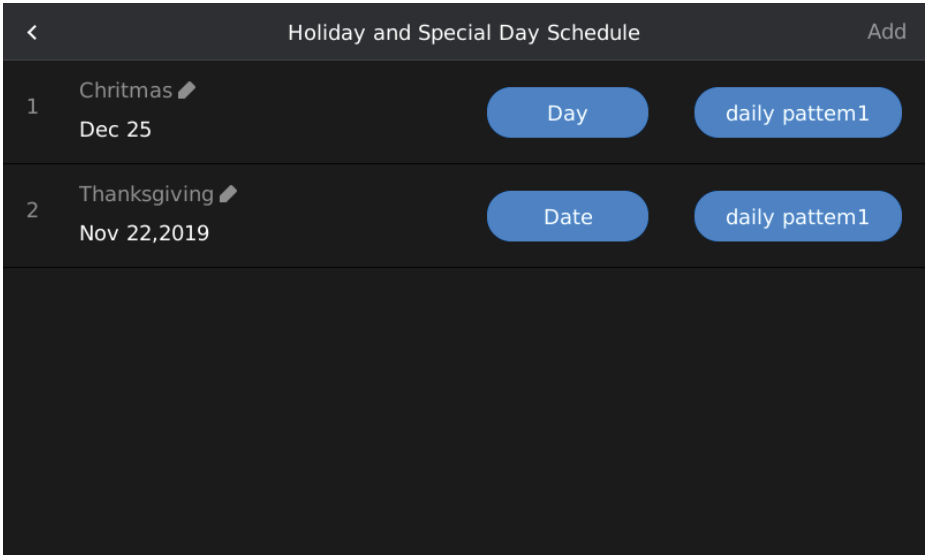

Figure 53. Holiday & Special Day Schedule Screen

Add a Holiday and Special Day Schedule

Tap the Add button to create a new holiday schedule. The new schedule displays at the end of the list.

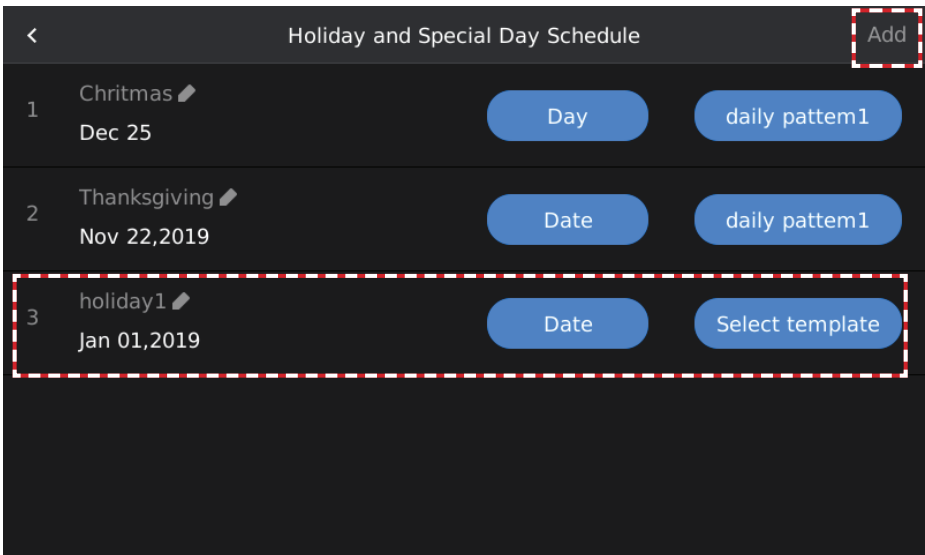

Figure 54. New Holiday & Special Day Schedule

Rename a Holiday and Special Day Schedules

Tap the name of the holiday schedule that you want to modify, enter the rename edit interface, and type the name of the holiday.

Tap YES to finish naming and modifying the holiday schedule, or tap NO to return to the previous page.

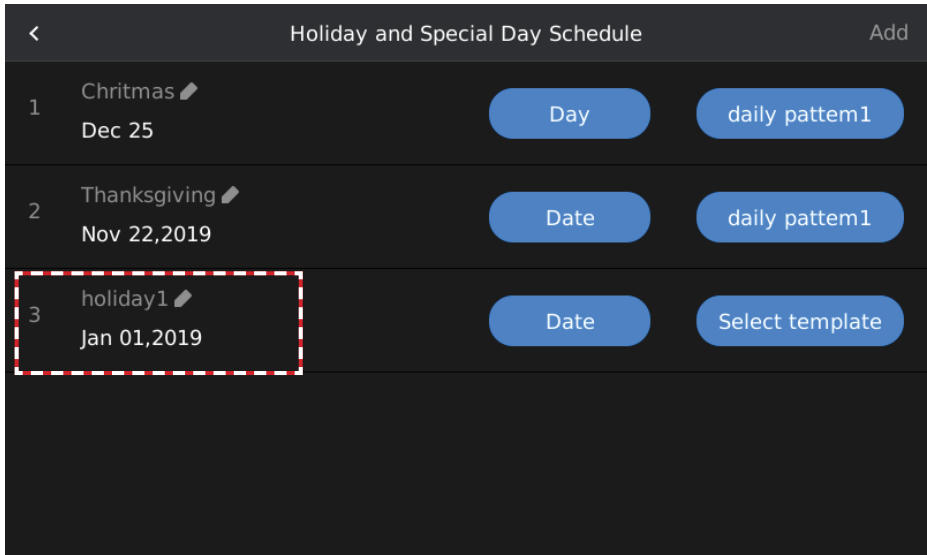

Figure 55. New Holiday & Special Day Schedule

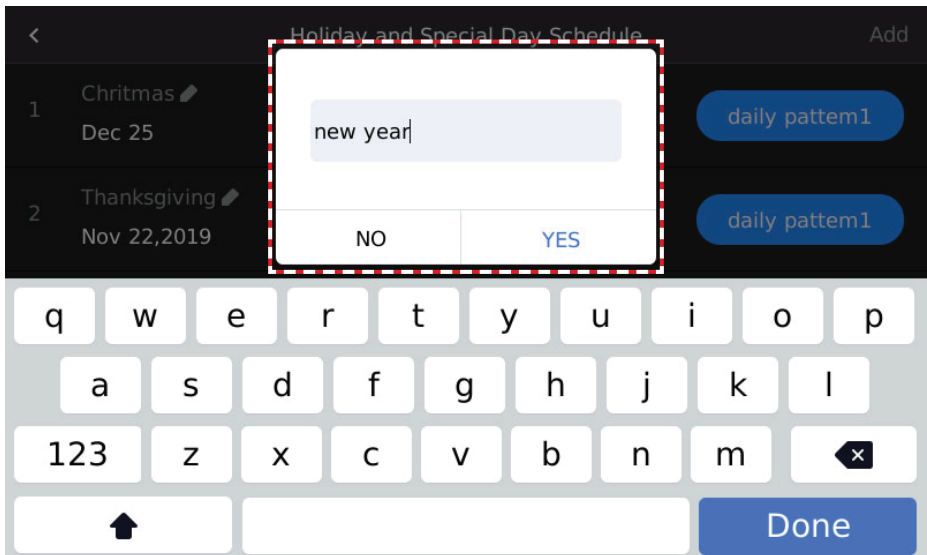

Figure 56. Rename Holiday & Special Day Schedule

Modify a Holiday and Special Day Schedules

Tap the Day button of the holiday schedule that needs to be edited, select the type of holiday schedule date setting and set the date.

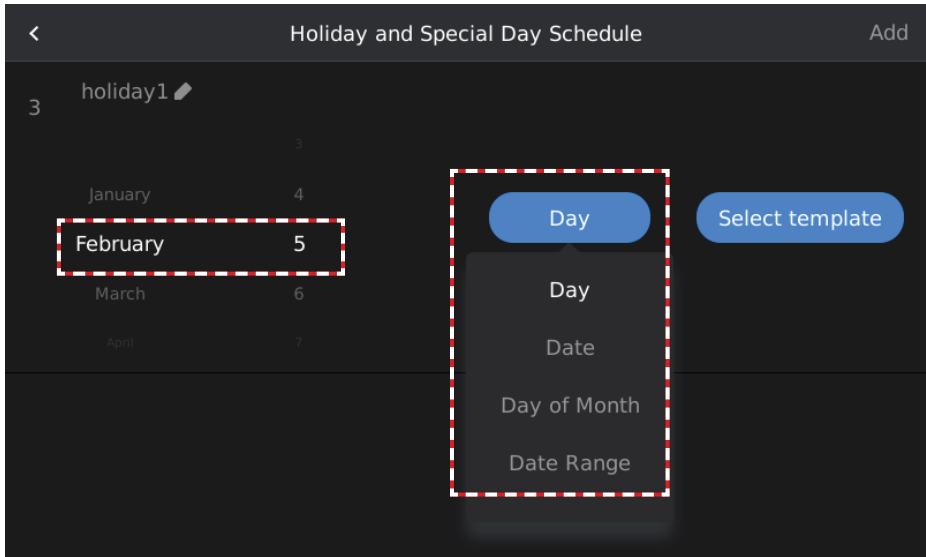

Figure 57 Select the Type of Holiday & Special Day Schedule

Tap the Select template button for the holiday schedule to be edited and select the daily schedule template for the holiday.

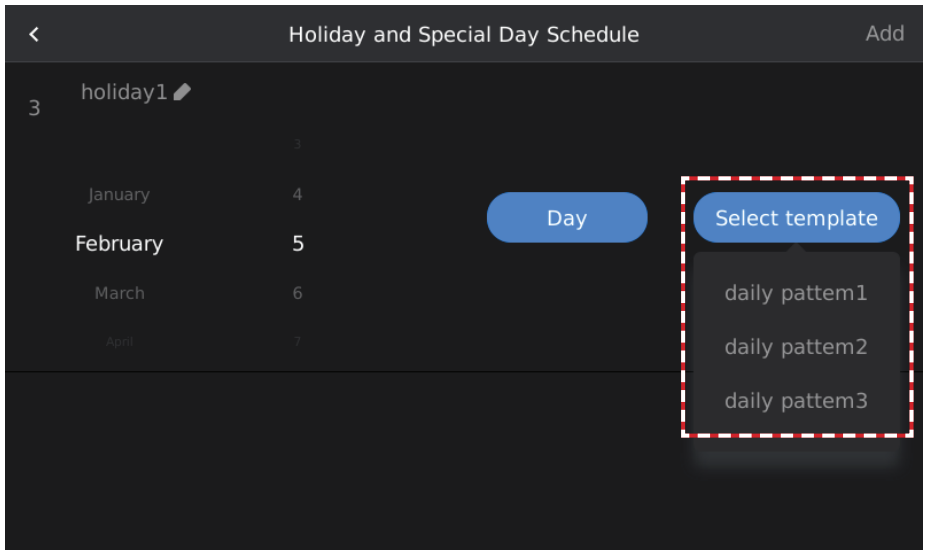

Figure 58. Select the Daily Schedule Template for the Holiday Schedule

Delete a Holiday and Special Day Schedules

Slide the holiday schedule (e.g., holiday1) that needs to be deleted from right to left, and then a Delete box will display.

Tap the Delete button to delete the selected holiday schedule.

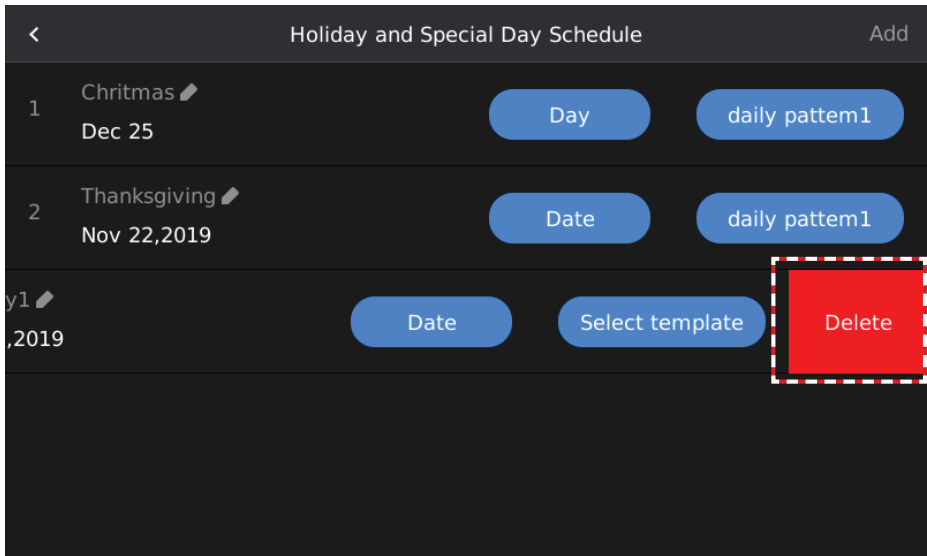

Figure 59. Delete Holiday & Special Day Schedule

Override Scheduled Settings

Set the system to operate according to the current settings rather than the weekly schedule settings for a period of time.

Tap the drop-down button on the right of Override Options to set the Override delay time. The Override time can be set to 30, 60, 90, or 120 minutes.

Clear will clear the set time.

After setting, the currently selected delay time is displayed to the right of Override Options.

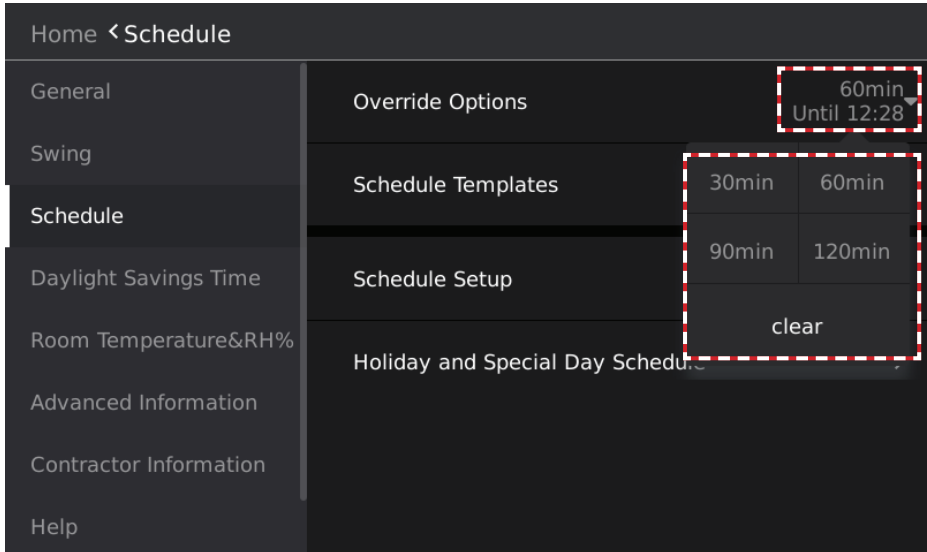

Figure 60. Override Scheduled Settings

The Override function is only active when the weekly schedule function is enabled. If the weekly schedule is inactive and the Override time is selected, the prompt box "Please activate schedule first" will display.

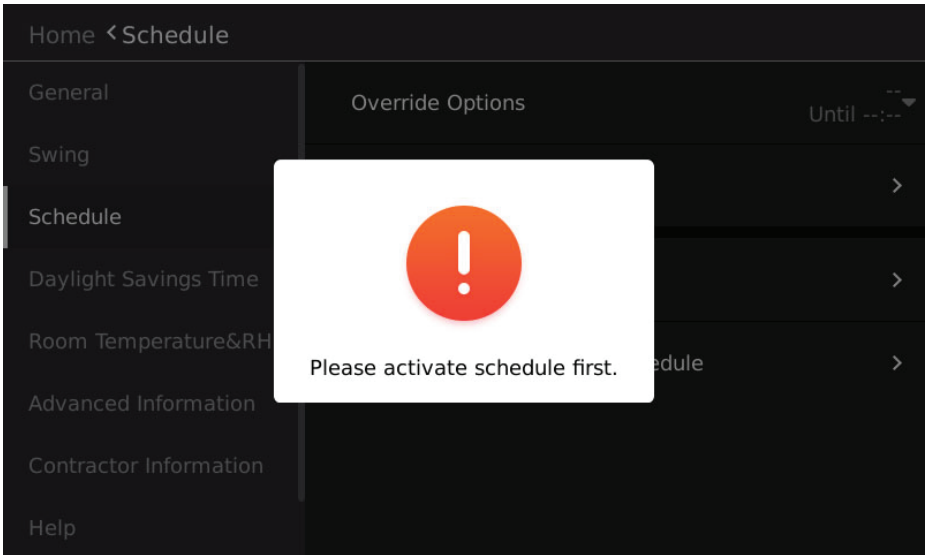

Figure 61. Activate Schedule Before Overriding Scheduled Settings

General Settings Configuration

Tap the Settings icon on the main interface to enter the Settings interface.

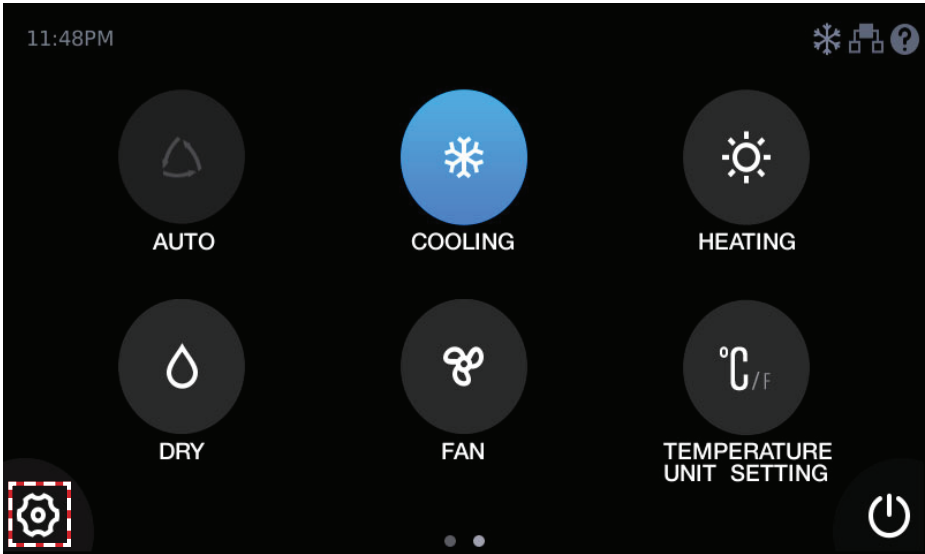

Figure 62. Access the Settings Interface

Tap the General button to enter the wired controller settings interface.

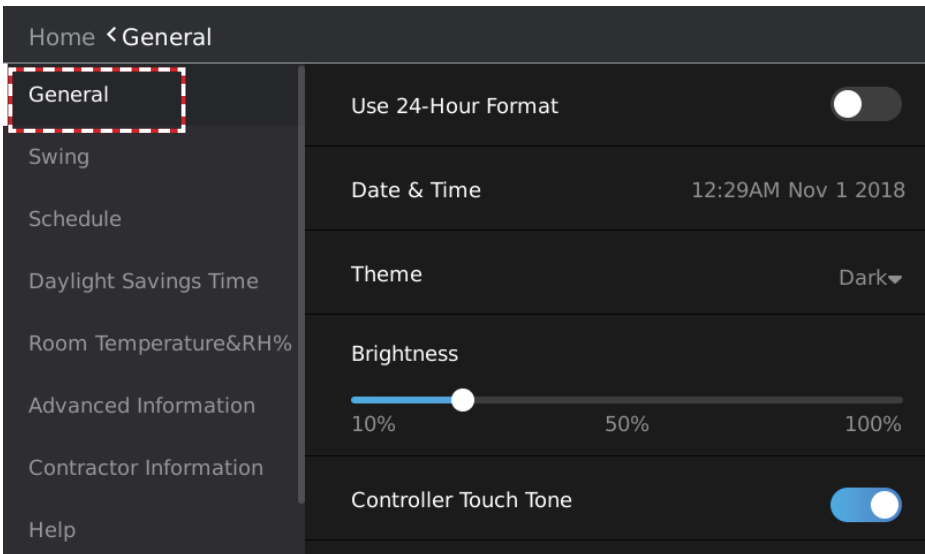

Figure 63. General Settings Screen

Time Format Settings

Slide or tap the button on the right of Use-24-Hour Format to switch between 12 hour and 24 hour clock display.

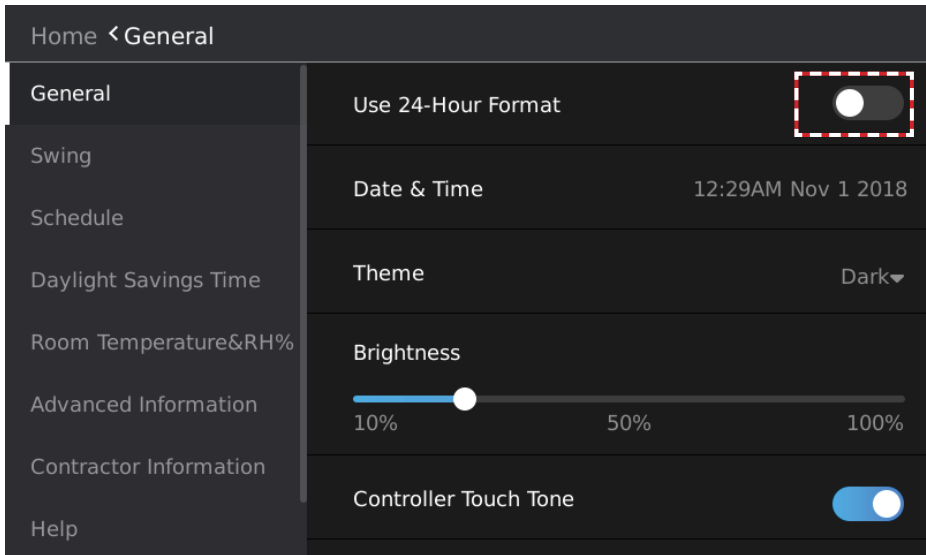

Figure 64. Time Format Settings

Time Settings

Tap the area to the right of Data & Time, and the time settings box will display. Slide up/down in the corresponding position to increase/decrease the value and change the time. The highlighted value in the middle is the currently set parameter.

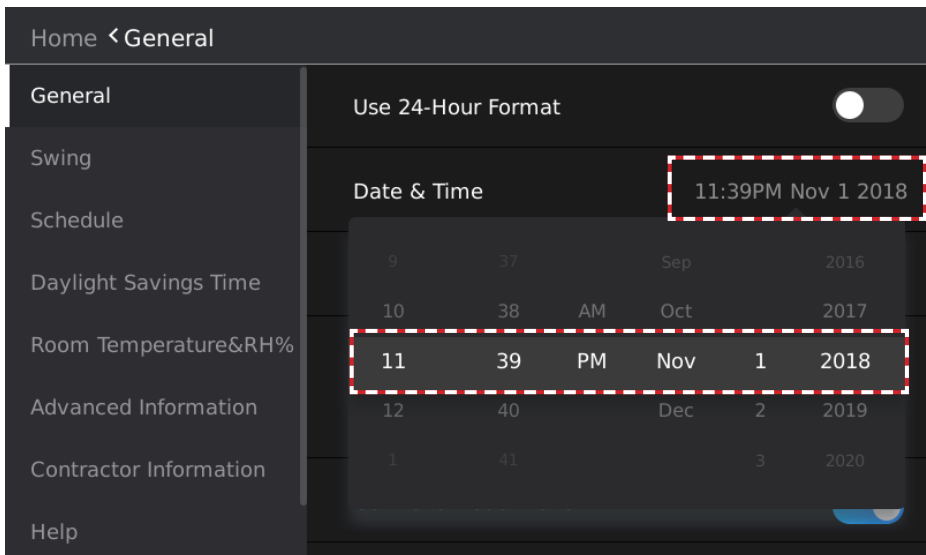

Figure 65. Time Settings

Theme Settings

Tap the drop-down symbol on the right of Theme and select a theme from the selection box that displays.

There are three themes: Dark, Colorful and Simple.

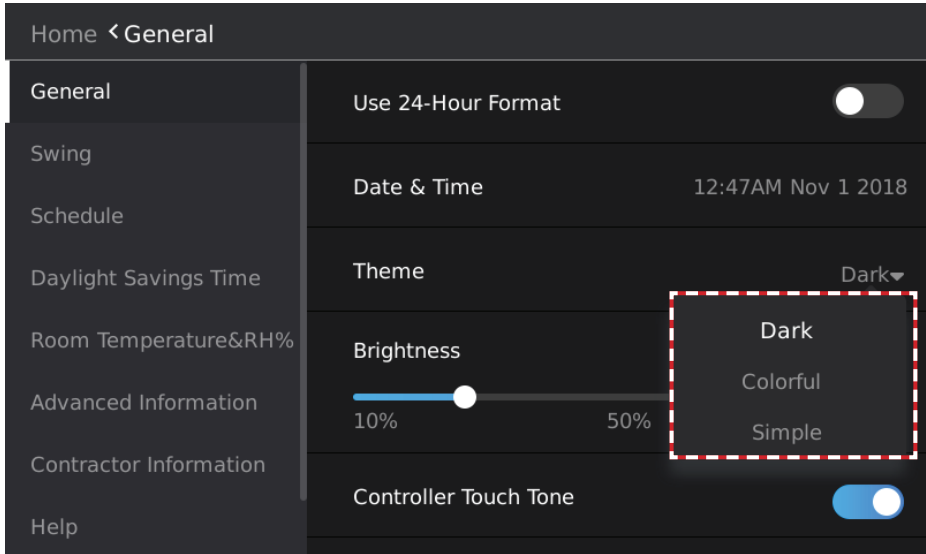

Figure 66. Theme Settings

Brightness Settings

Slide the button below Brightness to complete the brightness modification.

The brightness range is 10%-100%.

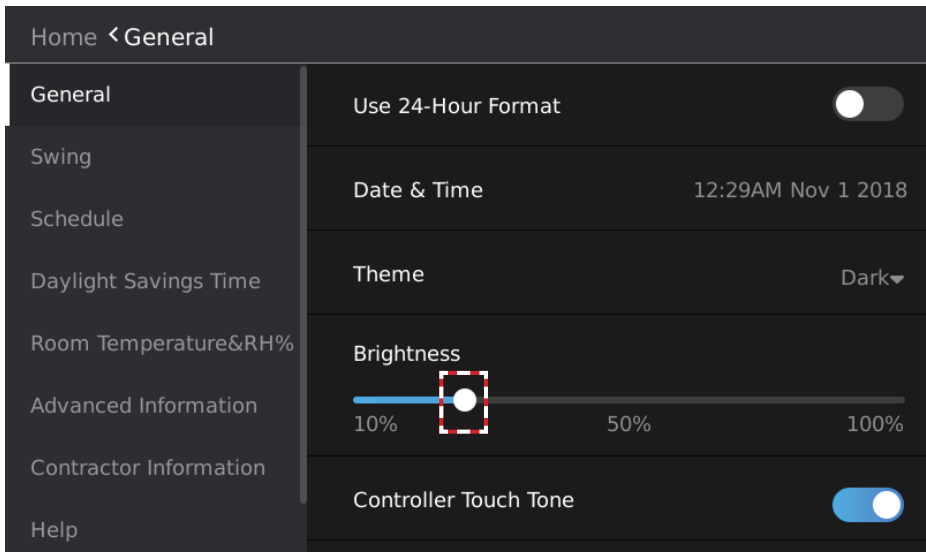

Figure 67. Brightness Settings

Controller Touch Tone (Sound) Settings

Slide or tap the button on the right of Controller Touch Tone to select whether the controller touch tone is active.

When the touch tone is inactive, neither the controller nor the indoor unit will beep when a command is sent to the indoor unit.

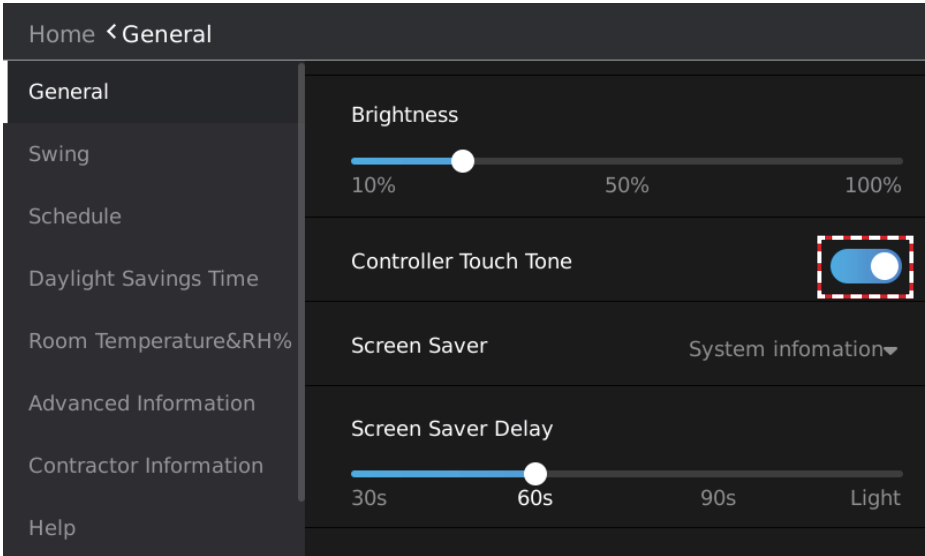

Figure 68. Touch Tone (Sound) Settings

Standby Interface (Screen Saver) Settings

Tap the drop-down symbol on the right of Screen Saver and select a standby screen in the selection box that appears.

The standby screen can be set to Blank, System Information, or Custom Image.

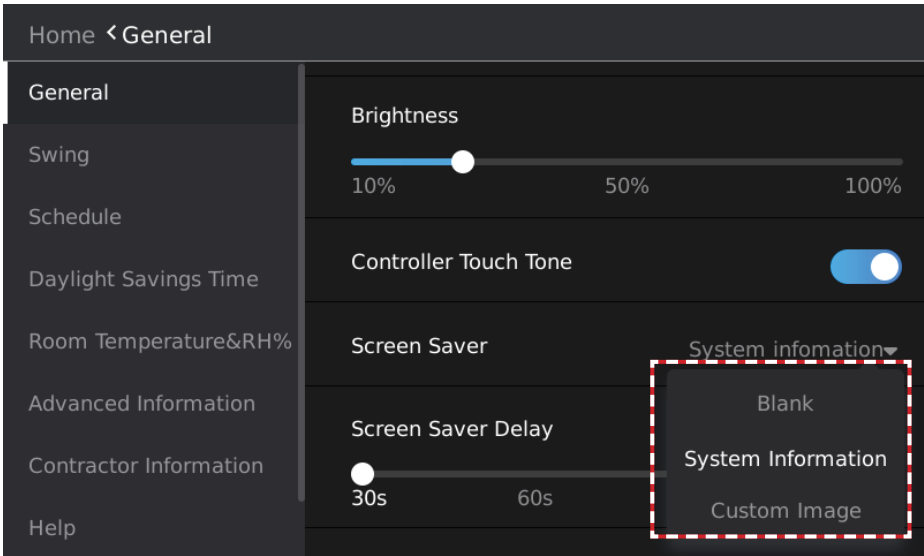

Figure 69. Standby Interface (Screen Saver) Settings

When you select the Custom Image theme, the box for selection of pictures on the USB will display. You can then select the custom picture to use.

Tap Save to save the theme settings, or tap Cancel to return to the previous interface.

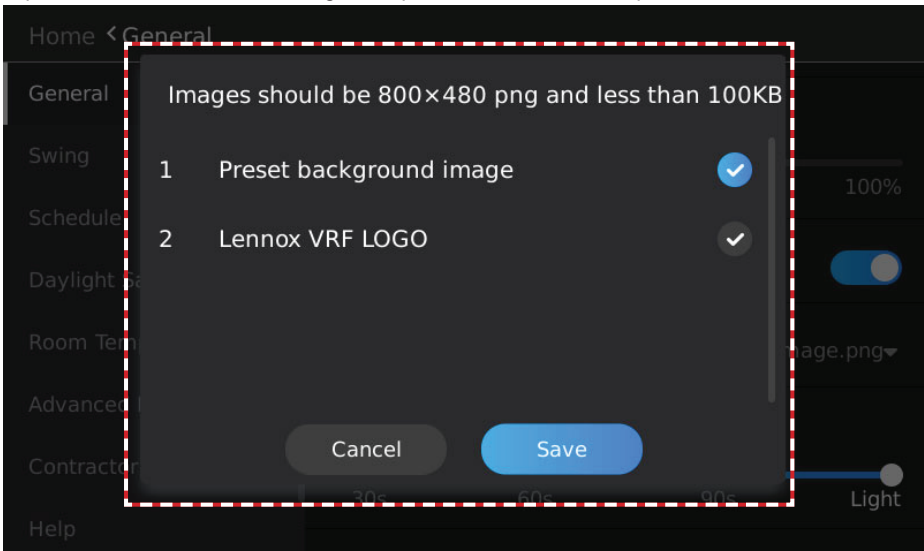

Figure 70. Select Custom Image

NOTE - Custom image resolution is 800*480, in .png format, and the size must not exceed 100 KB.

Standby (Screen Saver) Duration Settings

Slide the button below Screen Saver Delay and select a time period after which the system enters the standby interface when no operation is made.

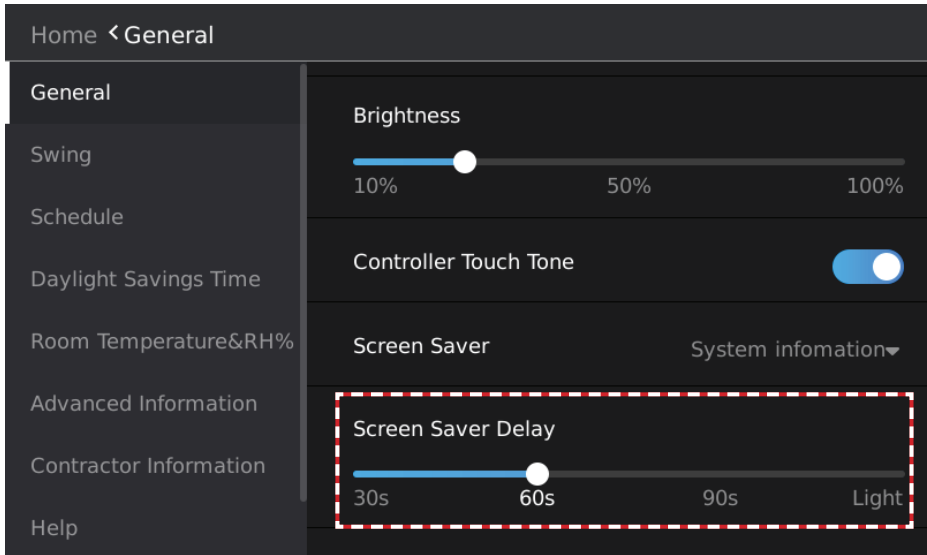

Figure 71. Standby (Screen Saver) Duration

Swing Angle Settings

Tap the Swing button to enter the swing angle settings interface.
Slide the Vertical button and select the angle of vertical swing.
Click the Horizontal button to select whether to enable horizontal swing.

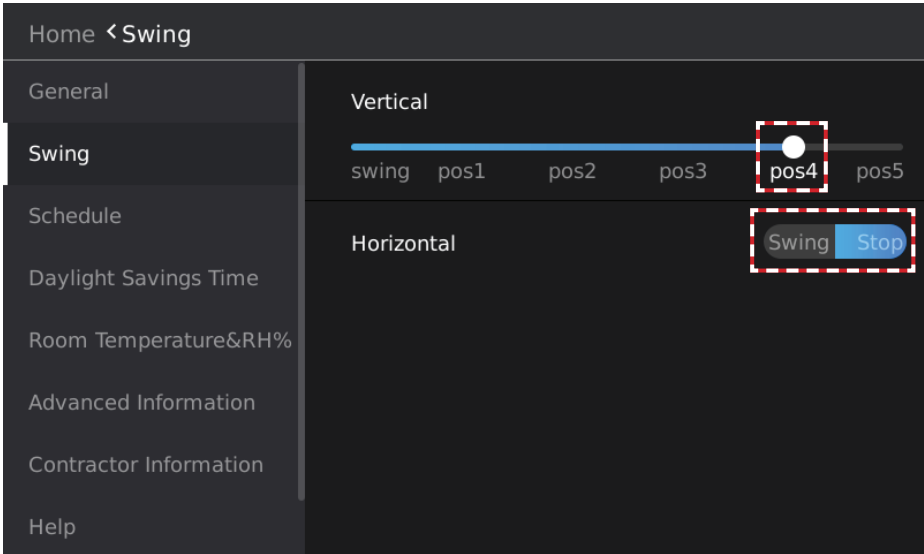

Figure 72. Swing Settings

Daylight Savings Time Settings

Tap the Daylight Savings Time button to enter the daylight savings time setting interface.

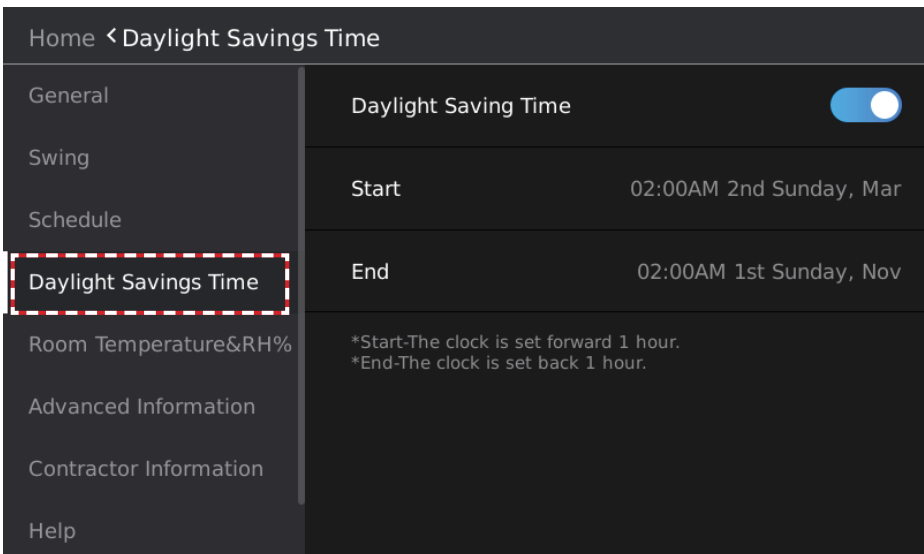

Figure 73. Daylight Savings Time Settings

Slide or tap the button on the right of Daylight Savings Time and select ON or OFF for daylight savings time.

Tap the time zone on the right of Start and select the starting time of the daylight savings time.

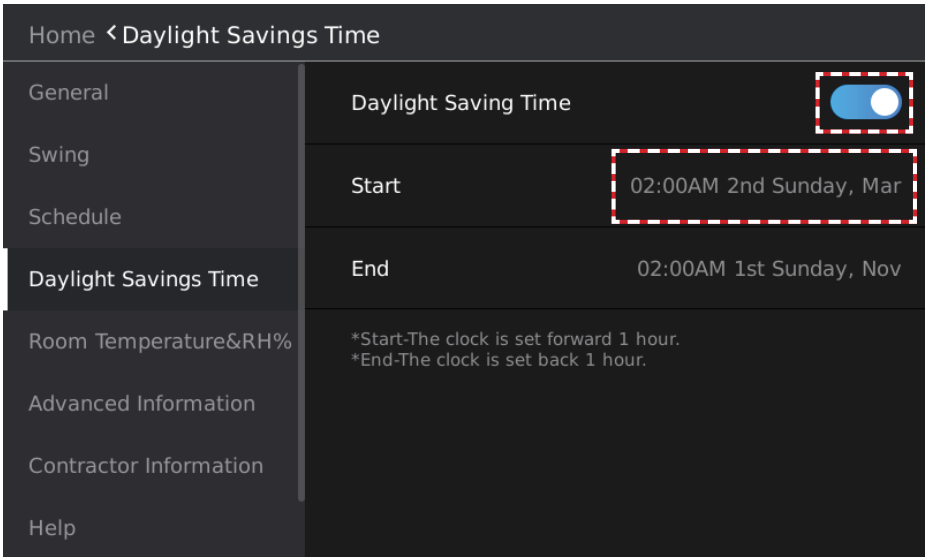

Figure 74. Select Start Date and Time

Slide the date that needs to be modified up or down. The highlighted value in the middle is the currently set parameter.

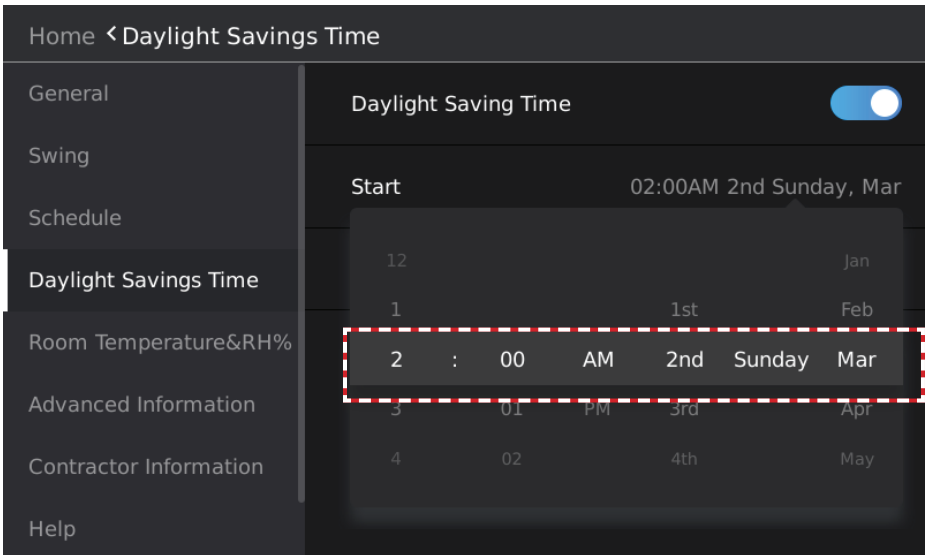

Figure 75. Select Start Date and Time

Tap the time zone on the right of End and select the ending time of the daylight savings time.

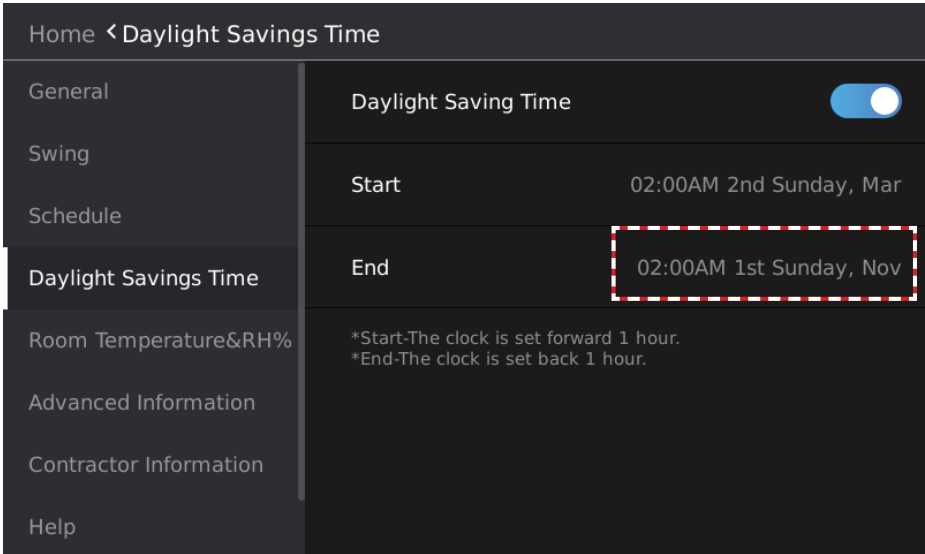

Figure 76. Select Daylight Savings Time Start Date and Time

Slide the date that needs to be modified up or down. The highlighted value in the middle is the currently set parameter.

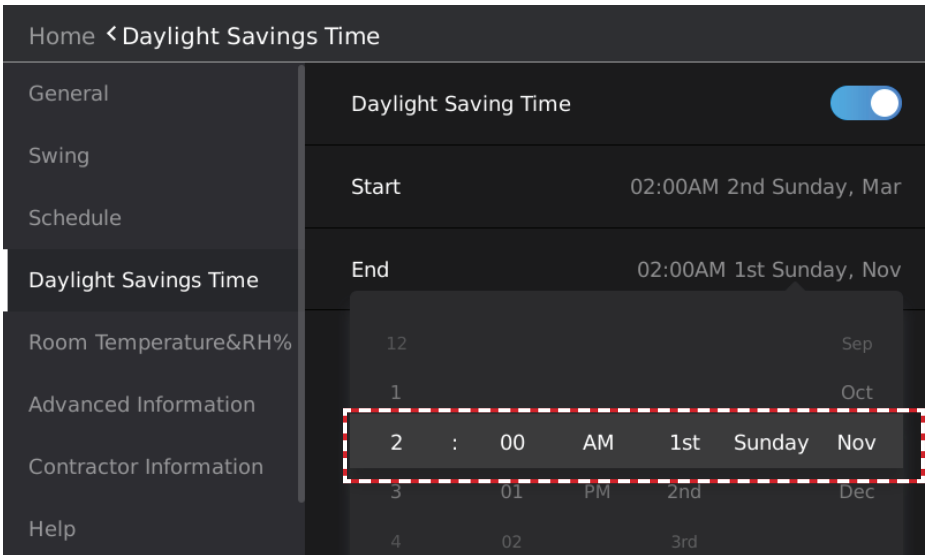

Figure 77. Select Daylight Savings Time End Date and Time

Room Temperature and Humidity Display Settings

Tap the Room Temperature&RH% button to enter the temperature and humidity display settings interface.

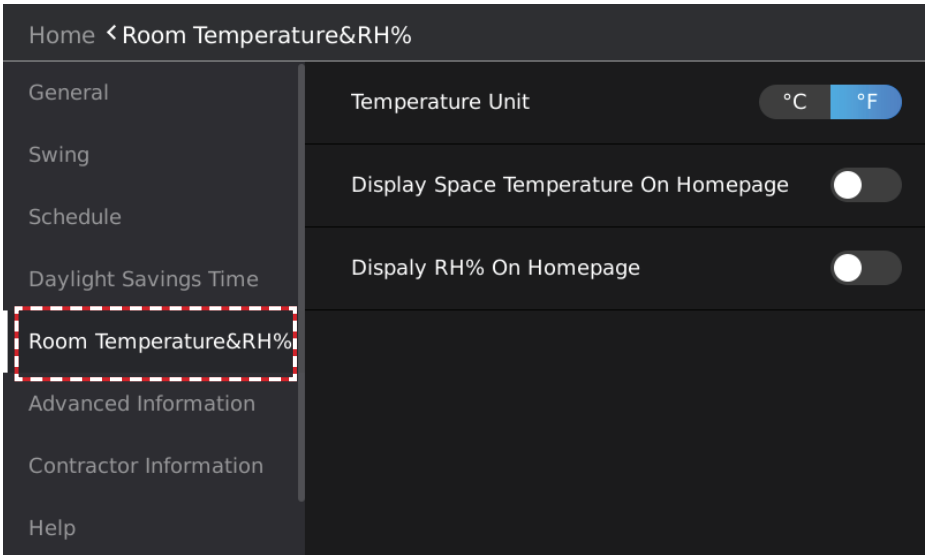

Figure 78. Room Temperature & Relative Humidity (RH) % Settings

Tap the °C/°F button on the right of Temperature Unit to switch the temperature units.

Tap or slide the button on the right of Display Space Temperature On Homepage to choose whether the main interface displays the temperature value.

Tap or slide the button on the right of Display RH% On Homepage to select whether the home page displays the humidity value.

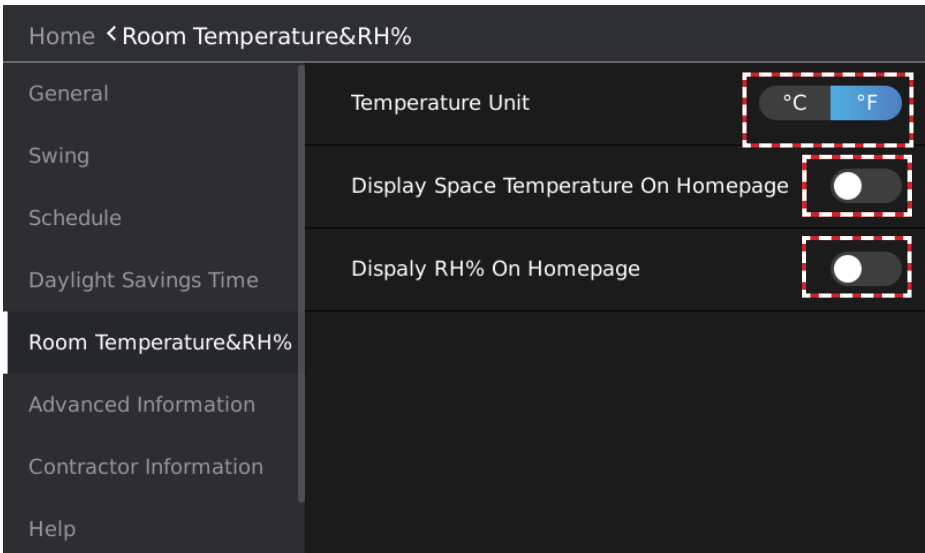

Figure 79. Room Temperature & Relative Humidity (RH) % Settings

Contractor Information Input

Tap the Contractor Information button to enter the contractor information input interface.

Home < Contractor Information

General

Swing

Schedule

Daylight Savings Time

Room Temperature&RH%

Advanced Information

Contractor Information

Help

Name:

Company Name:

Address:

Phone Number:

Email Address:

Web Site:

Figure 80. Contractor Information

Type the information you want to display using the input information interface.

Tap YES to finish information input, or tap NO to return to the previous page.

Home < Contractor Information

General

Swing

Schedule

Daylight Savings Time

NO YES

q w e r t y u i o p

a s d f g h j k l

123 z x c v b n m

Done

Figure 81. Enter Contractor Information

Service Menu

Access Service Menu

- Tap the Service Menu button to enter the password entry interface.
- Tap the corresponding number buttons to enter the correct service password.
- During password entry, tap the backspace key "←" to delete information.
- Tap X to clear all input information.
- The user password can be changed on the Lock screen within the Service Configuration Options. The default password is 0000.

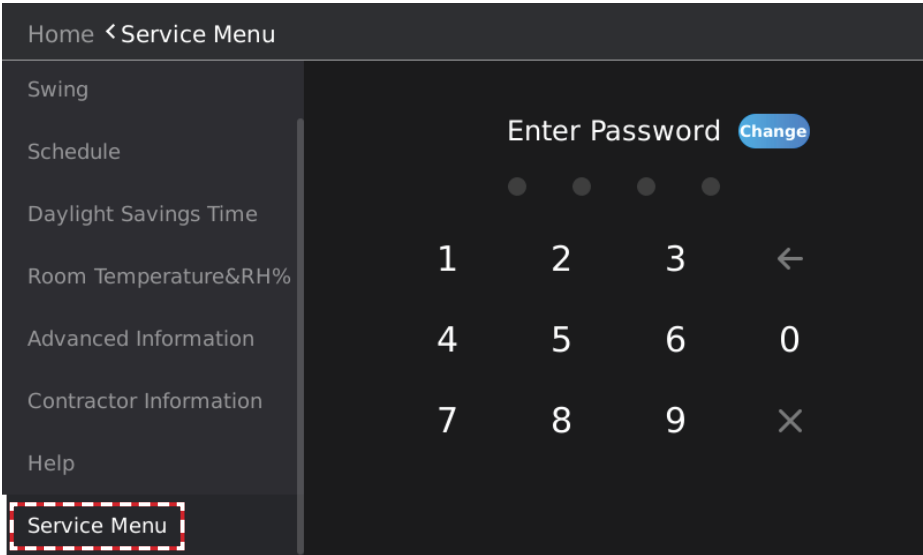

Figure 82. Access Service Menu

Change Password

1. Tap the Change button to enter the password modification interface. Tap the corresponding number buttons and enter the old password once, and the new password twice.
2. Tap YES to confirm the password modification, or tap Cancel to exit the password modification interface.

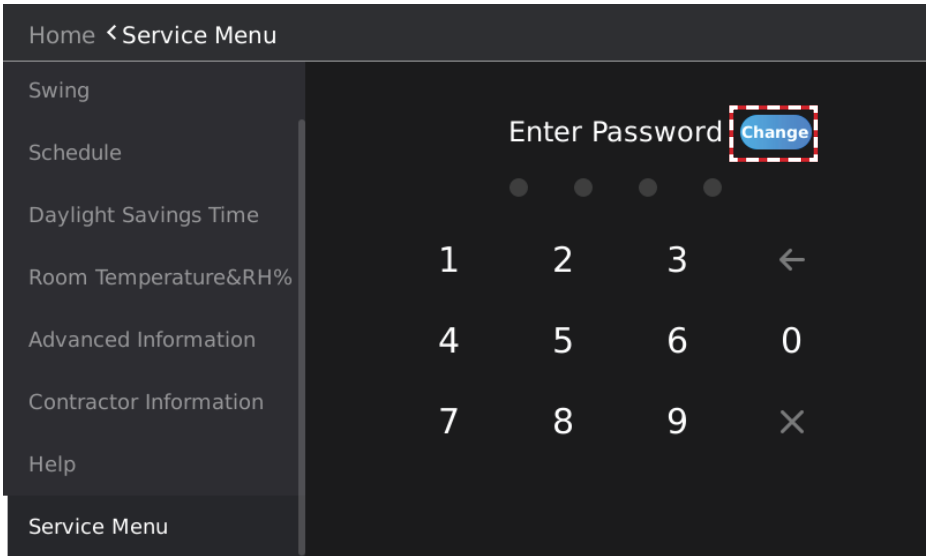

Figure 83. Change Password

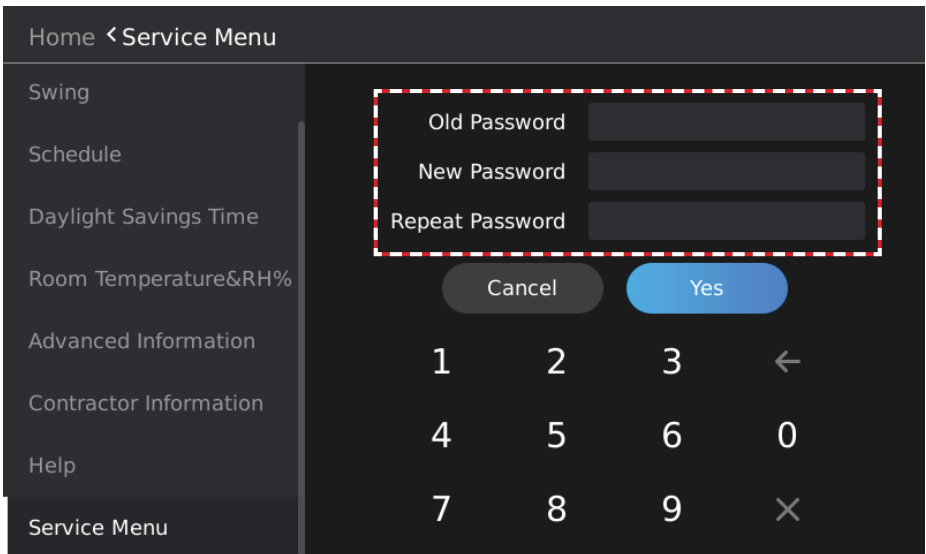

Figure 84. Enter New Password

Master / Sub Wired Controller Settings

1. Tap the Master/Sub button to enter the Master / Sub wired controller setting screen.
2. Tap the Master or Sub button to identify the wired controller as a master/Sub controller.
3. Tap the Change button, and then the Restart the system to implement the change box will display. Tap "ok". The settings will be applied and the wired controller will restart automatically.

NOTE - Only one master controller is allowed in each group of indoor units.

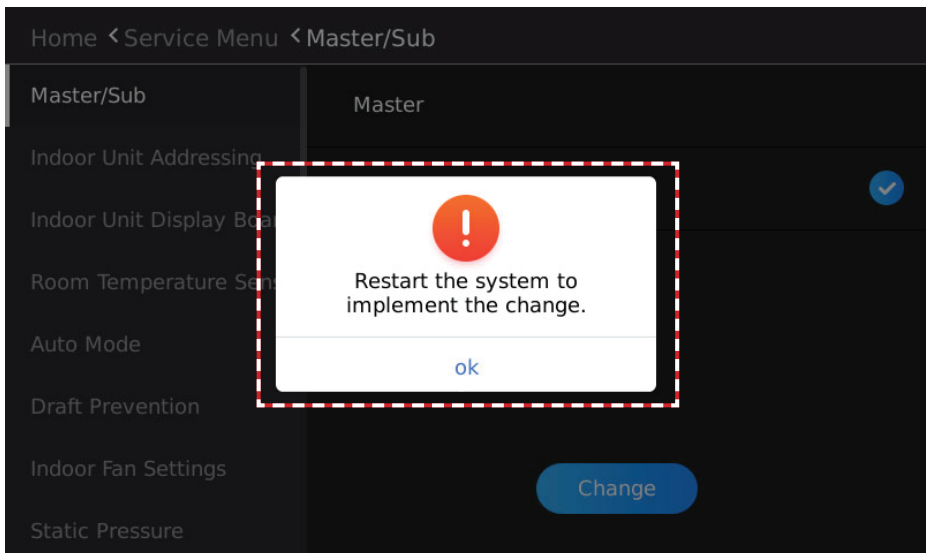
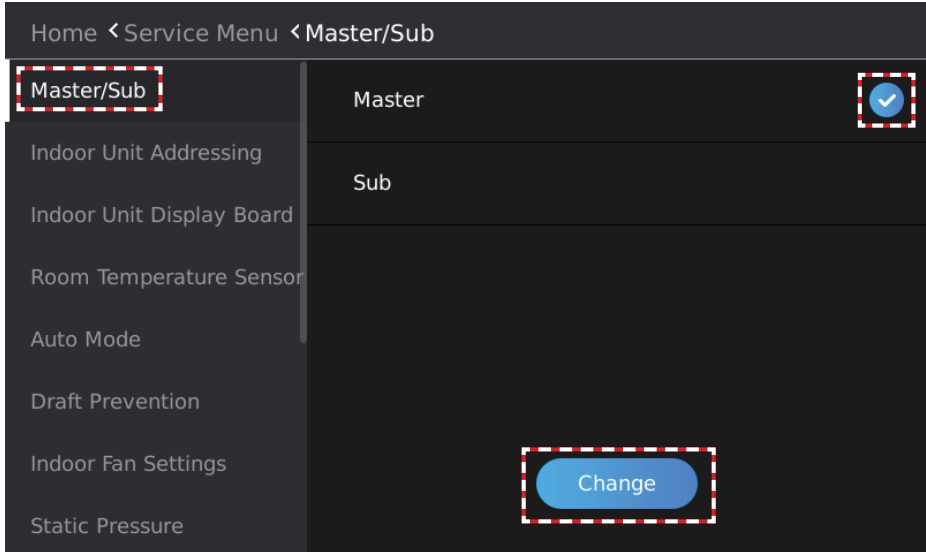

Figure 85. Identify Controller as Master or Sub

Master / Sub Wired Controller Operation

Up to two controllers can be connected to an indoor unit or group of indoor units. When two controllers are connected, one controller is the master controller and one is the sub controller for that indoor unit or group of indoor units.

Both the master and sub controller can change the indoor unit's operation. Other functionality is limited to the master controller.

Table 4. Master/Sub Controller Operation of Indoor Unit

Function	Master Controller Available	Sub Controller Available	Synchronize Controller Display
ON/OFF	Yes	Yes	Yes
Mode(Auto/Cooling/Heating/Dry/Fan)	Yes	Yes	Yes
Fan Speed	Yes	Yes	Yes
Setpoint	Yes	Yes	Yes
Swing	Yes	Yes	Yes
Schedule (including holidays)	Yes	No	No
Override	Yes	No	No
Temperature Unit Display Setting (°F/°C)	Yes	No	No
Setpoint Limit	Yes	No	No

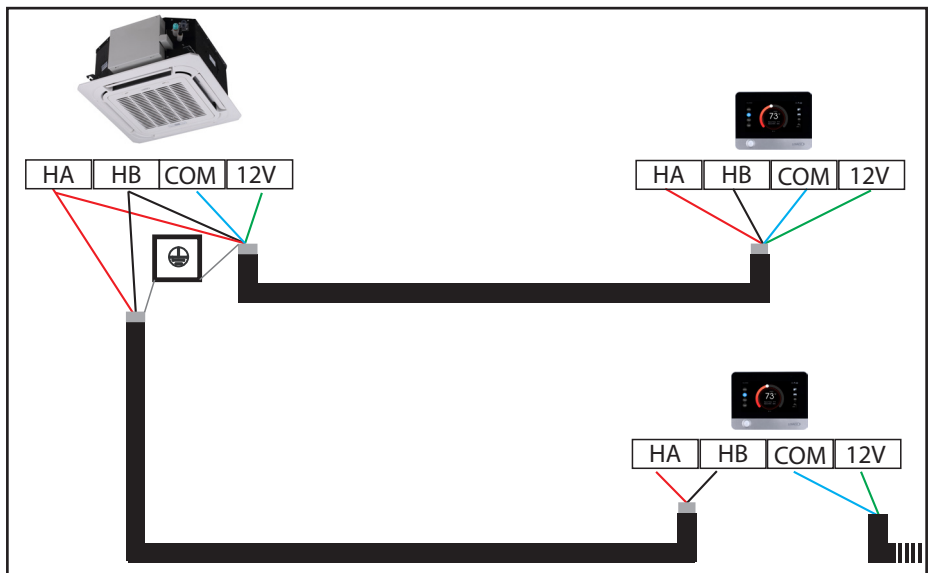

Figure 86. Master/Sub Configuration: V0STAT51 Master & V0STAT51 Sub

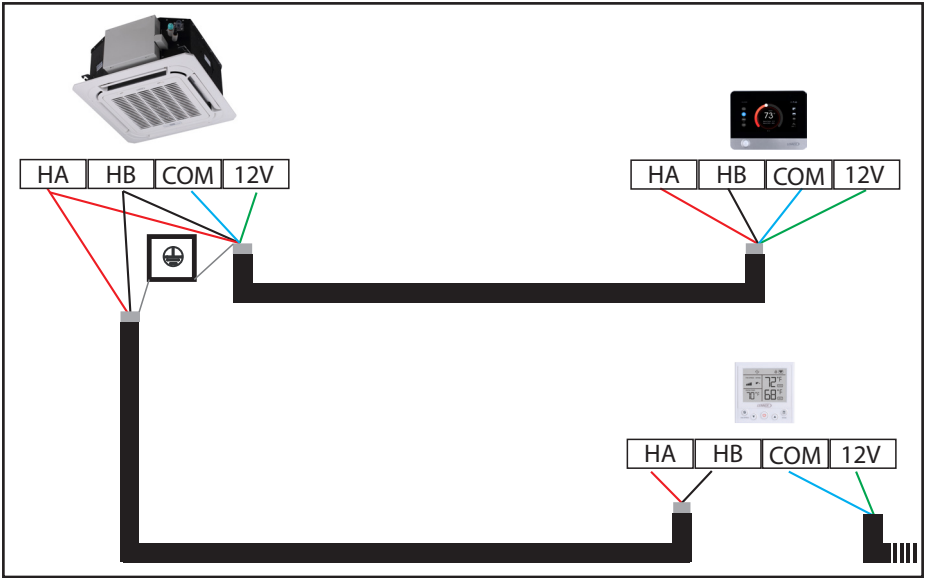
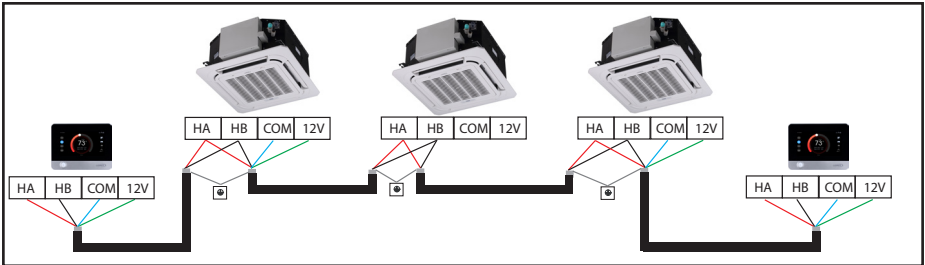
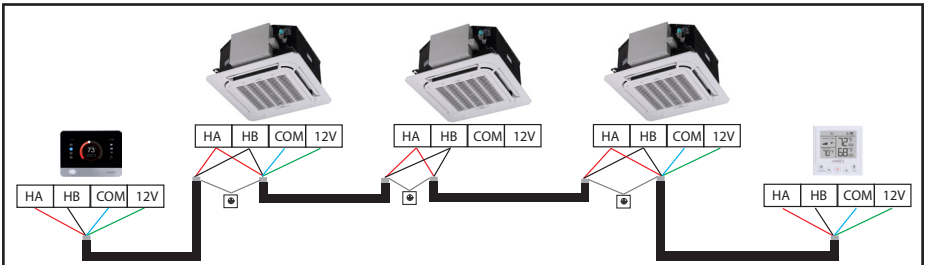

Figure 87. Master/Sub Configuration: V0STAT51 Master & V0STAT54 Sub



**Figure 88. Master/Sub Configuration: Multiple Indoor Units Connected
V0STAT51 Master & V0STAT54 Sub**



**Figure 89. Master/Sub Configuration: Multiple Indoor Units Connected
V0STAT51 Master & V0STAT54 Sub**

Indoor Unit Address Settings

1. Tap the Indoor Unit Addressing button on the screen to enter the Indoor unit address settings screen.
2. Slide the number left and right, and select the address value that you want to assign to the connected indoor unit.
3. Tap the Set button, and then the Need reboot to effective dialog will display.
4. Tap Ok. The settings will take effect and the wired controller will restart automatically.

NOTE - Requires a one-to-one connection to the indoor unit.

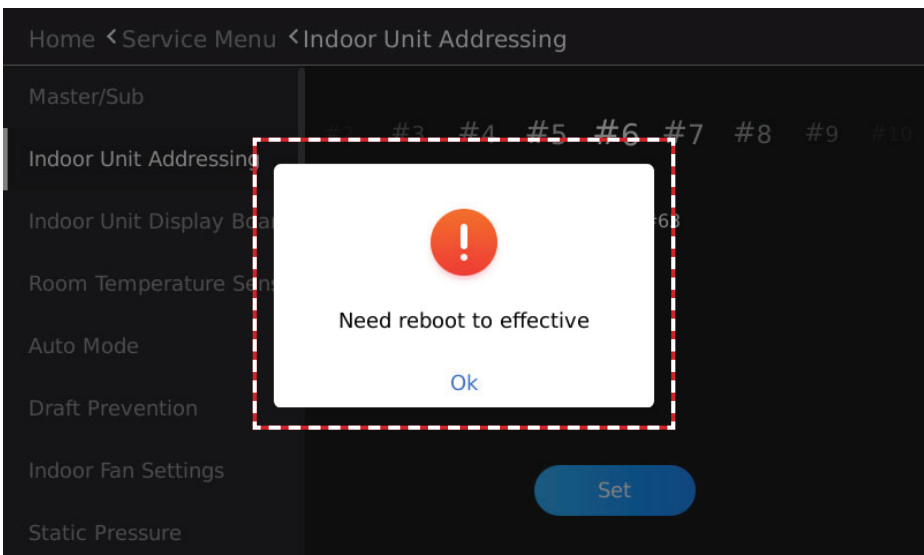
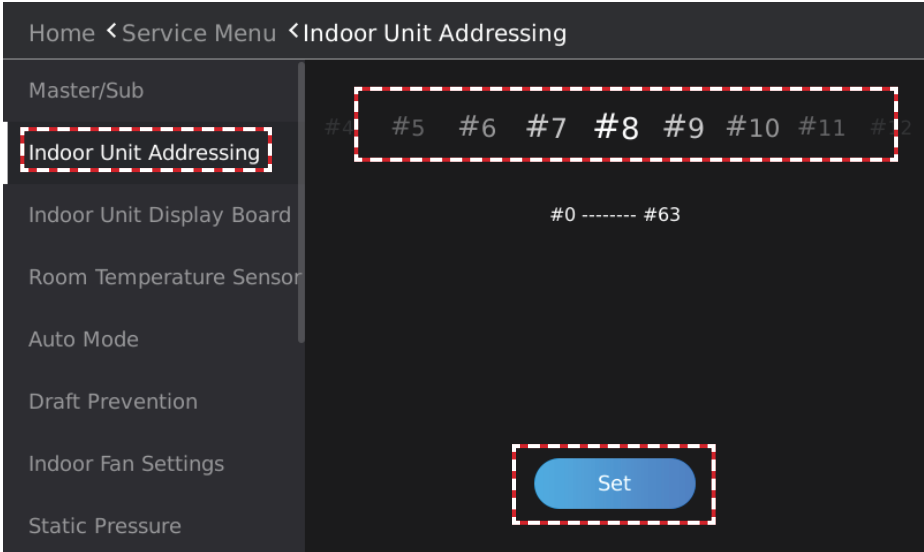

Figure 90. Assign Indoor Unit Address

Indoor Unit Display Board & Buzzer (Sound) Settings

1. Tap the Indoor Unit Display Board button to access the Indoor unit display board and buzzer settings screen.
2. Slide or tap the button on the right of Display Board to select whether to enable the display function of the indoor unit display board.
3. Slide or tap the button on the right of Buzzer to select whether to enable the buzzer (sound) function of the indoor unit display board.

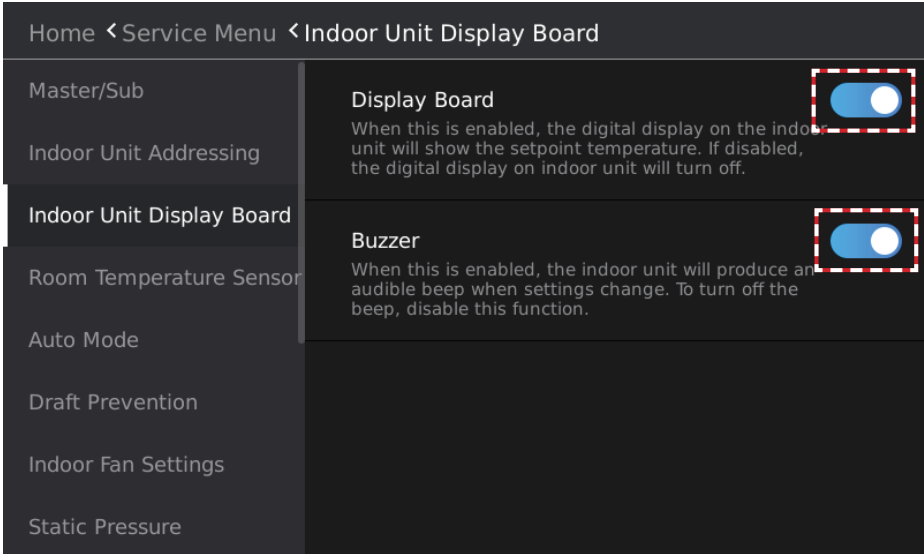

Figure 91. Indoor Unit Display & Buzzer (Sound) Settings

Room Temperature Sensor Settings

1. Tap the Room Temperature Sensor button to access the room temperature sensor settings screen.

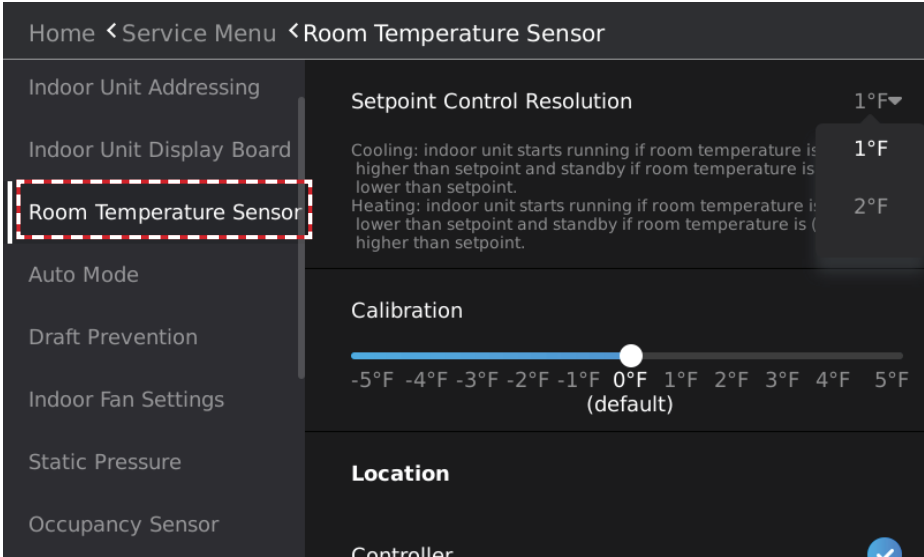

Figure 92. Room Temperature Sensor Settings

2. Tap the drop-down button on the right of Setpoint Control Resolution and select the return difference temperature.
3. Slide the Calibration button and select the room temperature calibration value.

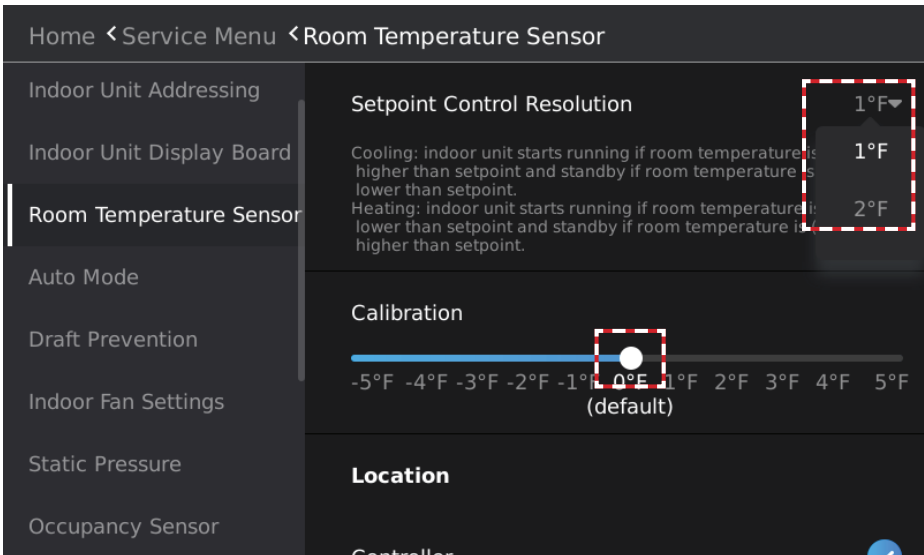

Figure 93. Room Temperature Control Resolution & Calibration

Tap the button below Location and select the Return Air (T1) temperature sensor location.
Controller. Use the controller's T1 (return air) sensor for all connected indoor units.
Individual Indoor Unit. All connected indoor units will use their own T1 (return air) sensor.
Select One Of The Indoor Units. All connected indoor units will use the T1 (return air) sensor of the selected indoor unit. Tap the drop-down button on the right and select the address of indoor unit.

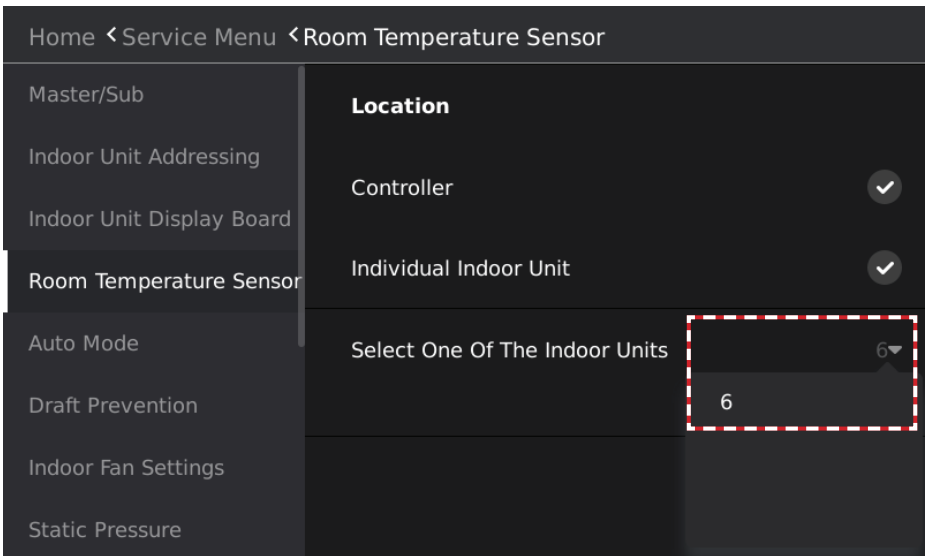
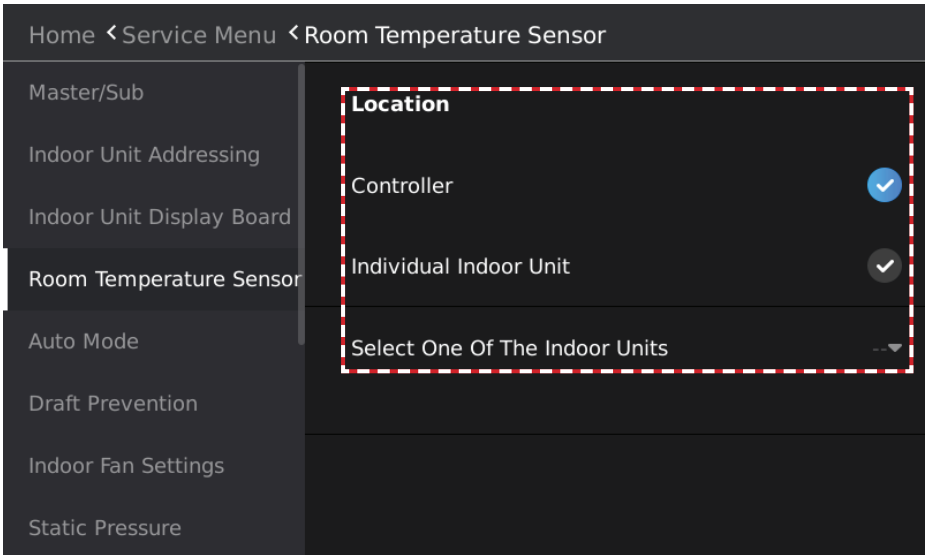

Figure 94. Select Return Air Sensor Location

Auto Mode Settings

- Tap the Auto Mode button to access the room auto mode settings screen.

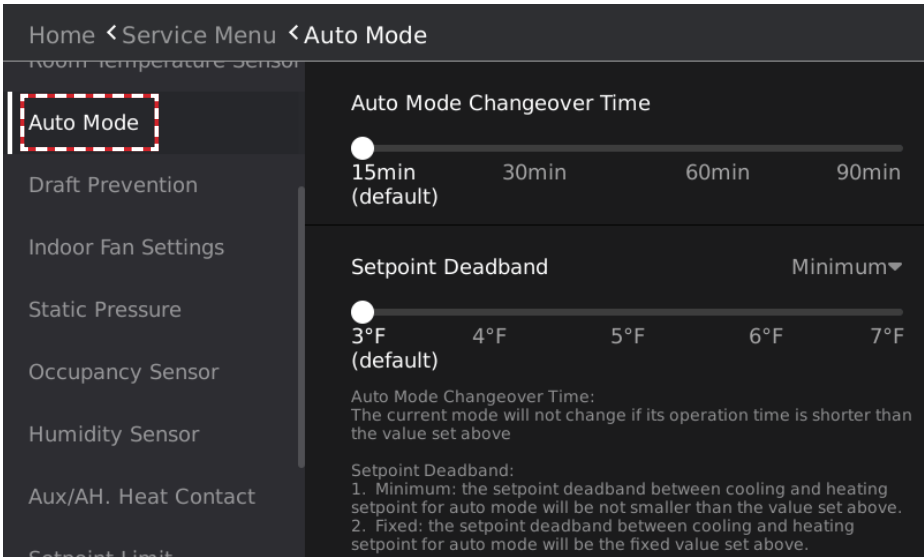

Figure 95. Auto Mode Settings

- Slide the button below Auto Mode Changeover Time and select the auto mode changeover time.

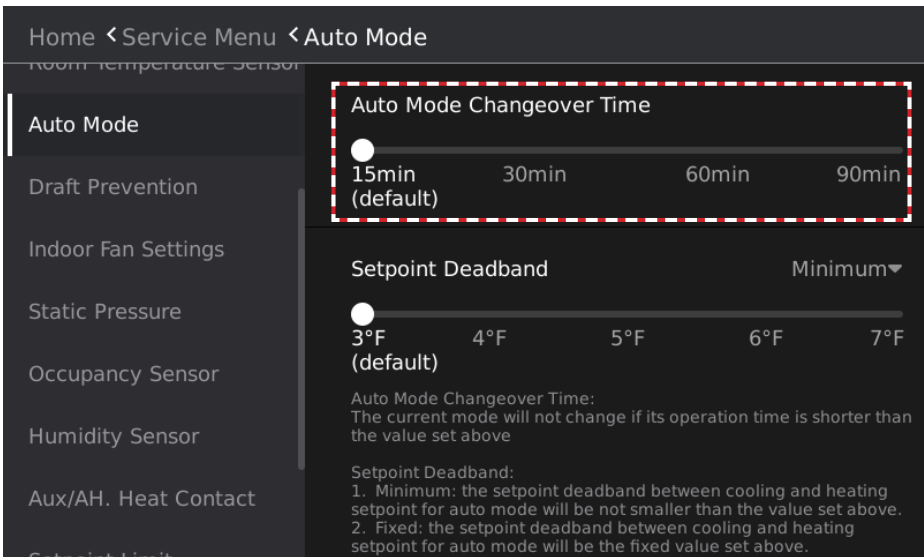

Figure 96. Auto Mode Changeover Time

- Tap the drop-down button on the right of Setpoint Deadband and select the method for setting the temperature difference between the cooling setpoint and heating setpoint in Auto mode.
- When the Setpoint Deadband in Auto mode is set to Minimum, the temperature difference between the cooling setpoint and the heating setpoint is set to a minimum value.
- When the Setpoint Deadband in Auto mode is set to Fixed, the temperature difference between the cooling setpoint and the heating setpoint is set to a fixed value.
- Slide the button below Setpoint Deadband and select the difference between the setpoint for auto mode in cooling and the setpoint for auto mode in heating.

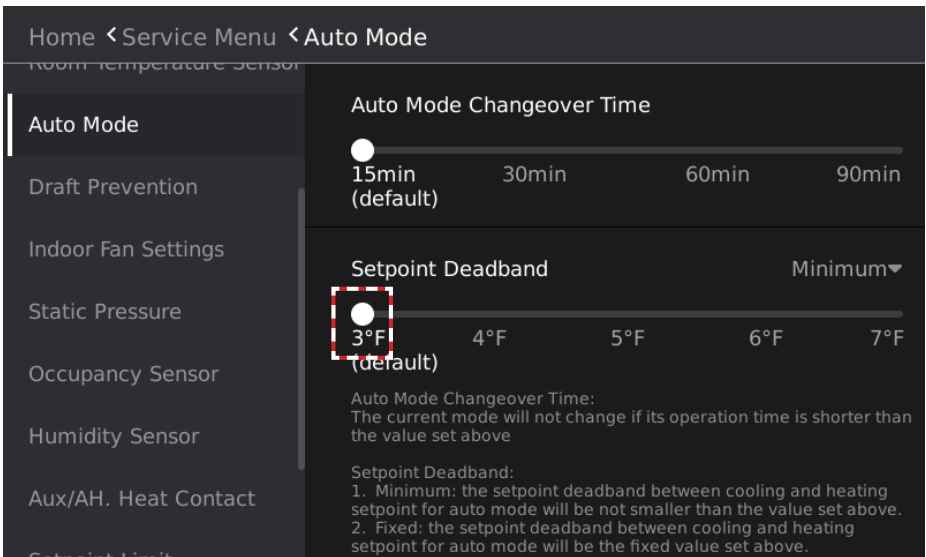
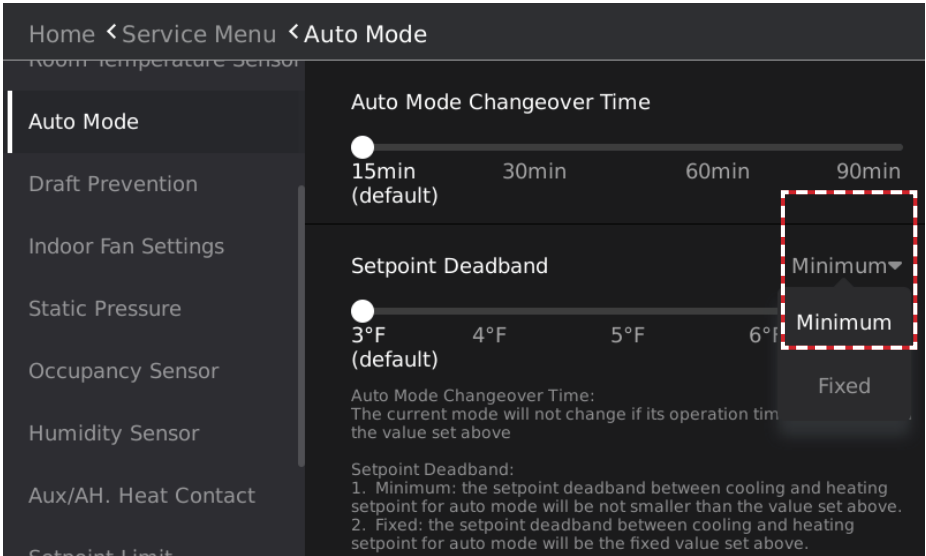

Figure 97. Auto Mode Setpoint Deadband

Draft (Cold Blow) Prevention Settings

Set the temperature the coil must reach before the fan engages to prevent cold air from being distributed from the indoor unit.

1. Tap the Draft Prevention button to enter the cold air prevention temperature settings page.
2. Slide the temperature selection button and select the cold air prevention temperature set value.

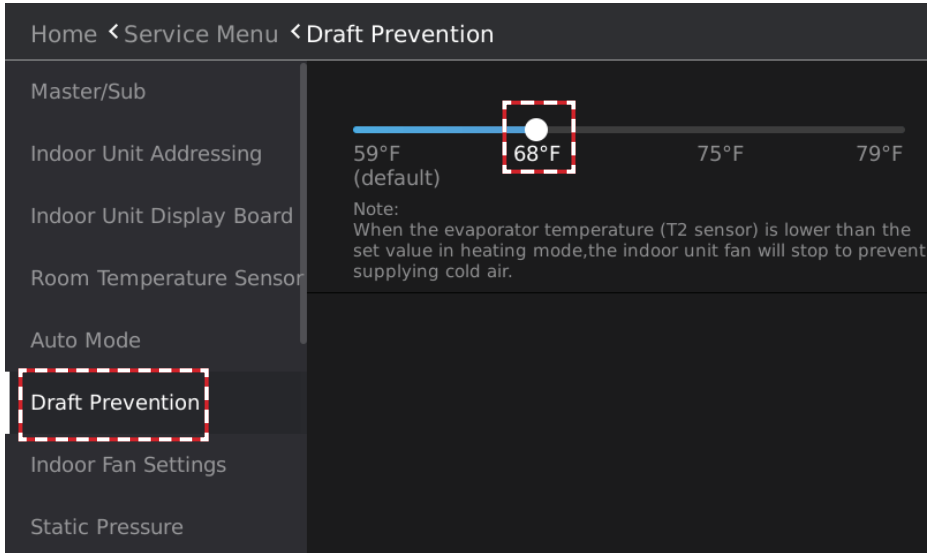

Figure 98. Draft (Cold Blow) Prevention

Stand-by Fan Speed Settings

Set the indoor unit fan operation when the indoor unit setpoint is satisfied.

1. Tap the Indoor Fan Settings button to enter the stand-by fan speed settings interface.
2. Slide the button below Cooling and select the fan status setting when the cooling setpoint is satisfied.
3. Slide the button below Heating and select the fan status setting when the heating setpoint is satisfied.

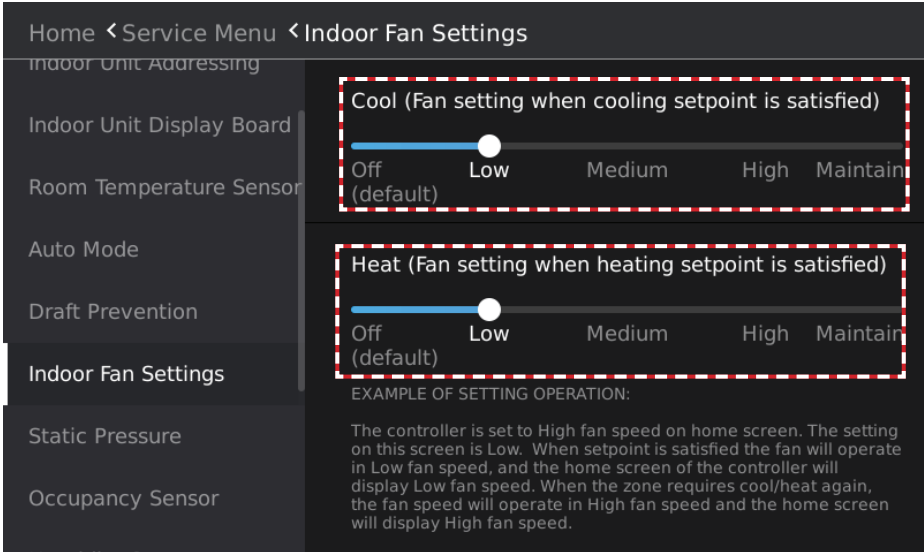

Figure 99. Indoor Fan Settings

Indoor Unit Static Pressure Settings

Set the indoor unit static pressure. Ducted units only.

1. Tap the Static Pressure button to enter the static pressure settings screen.
2. Slide the static pressure selection button and select the static pressure setting.

NOTE - Requires a one-to-one connection to the indoor unit.

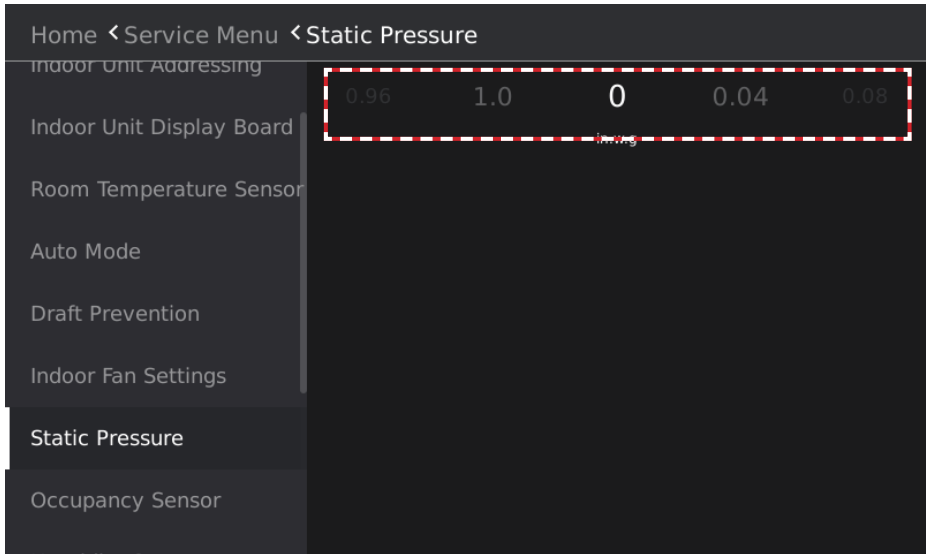

Figure 100. Static Pressure Settings

Occupancy Sensor Function Settings

Setup the controller's occupancy sensor.

1. Tap the Occupancy Sensor button to access the occupancy sensor function settings screen.
2. Slide the button on the right of Occupancy Sensor to select whether to enable the occupancy sensor function.
3. Slide the button below Delay to select the duration of the detection of the unoccupied status.
4. Slide the button below Unoccupied Setpoint Offset and select the temperature change value when unoccupied status is detected.
5. Tap the drop-down button on the right of Heating Set Back and select the temperature limit to enter the set back operation period.

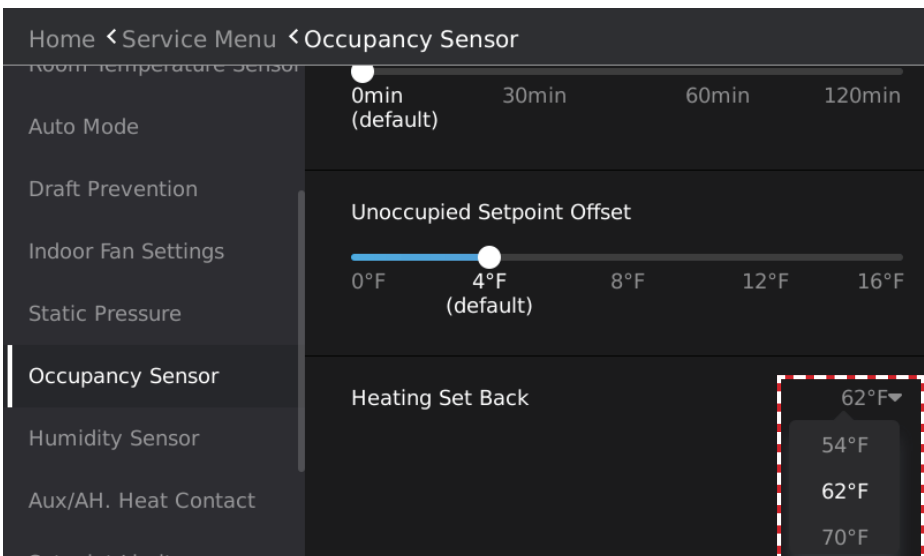
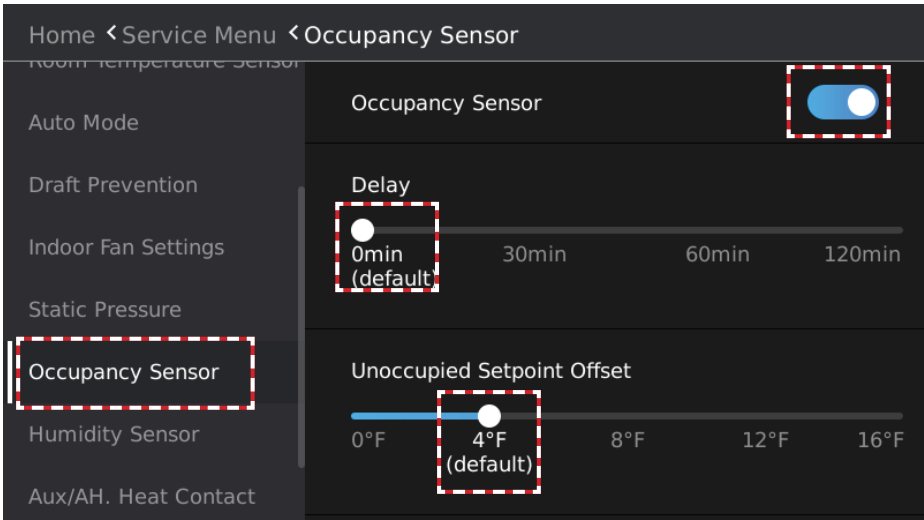

Figure 101. Occupancy Sensor Function Settings

Dry Mode Settings

Setup humidity sensing from the controller.

1. Tap the Humidity Sensor button to enter the auto dry mode settings screen.
2. Slide the button on the right of Auto Dry and choose whether to enable the Auto Dry function.
3. Slide the slider on the right of Dehumidifier Contact and select whether to install the dehumidifier in the indoor unit.
4. Slide the value below Target RH% to set the indoor target humidity. The highlighted value in the middle is the current set parameter.
5. Slide the number below Cutoff to set the limit when the Cutoff dehumidification operation temperature is lower than the set temperature. The highlighted value in the middle is the currently set parameter.

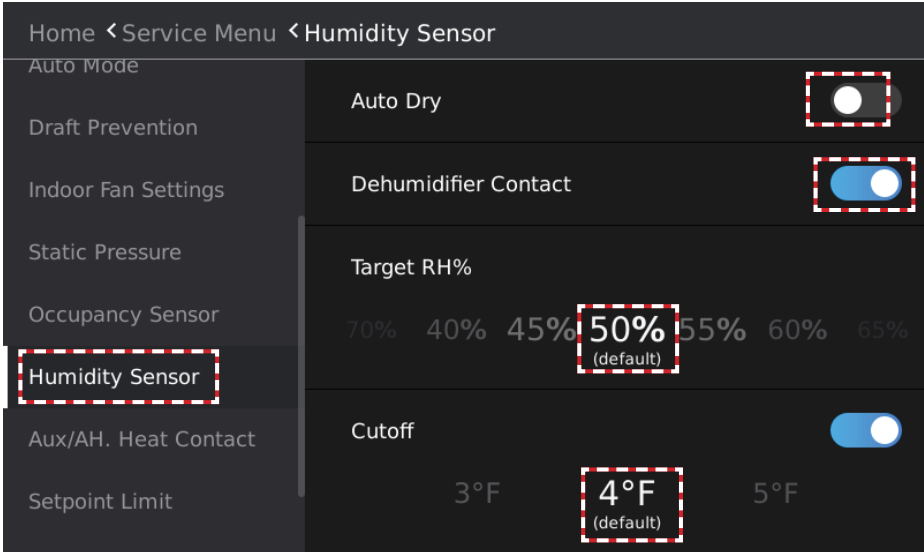

Figure 102. Occupancy Sensor Function Settings

Auxiliary / Alternate Heat Settings

Setup auxiliary and alternate heat source activation from the controller.

1. Tap the Aux/AH. Heat Contact button to access the auxiliary heat source function settings page.
2. Select the button on the right of No Auxiliary/Alternative Heat Installed, Aux/Alt Heat Installed at IDU or in Duct or Other Aux/Alt Heat Installation and confirm the installation method of the auxiliary heat source.

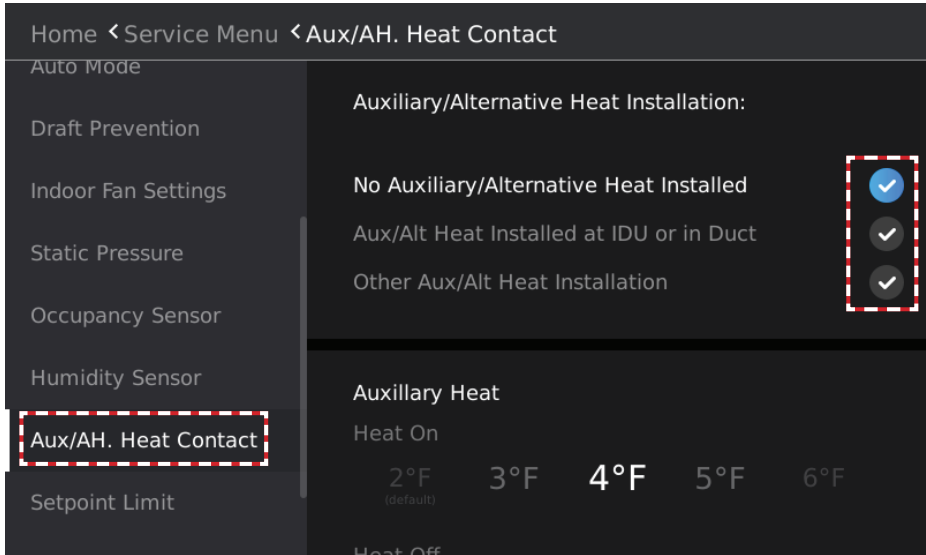

Figure 103. Auxiliary / Alternate Heat Settings

3. Slide the Heat On temperature value below Auxiliary heat. The highlighted value in the middle is the currently selected parameter. This means that when the indoor ambient temperature is Δt_1 lower than the set temperature, the external heat source is turned on.
4. Slide the Heat Off temperature value below Auxiliary heat. The highlighted value in the middle is the currently selected parameter. This means that when the indoor ambient temperature is Δt_2 higher than the set temperature, the auxiliary heat source is turned off.

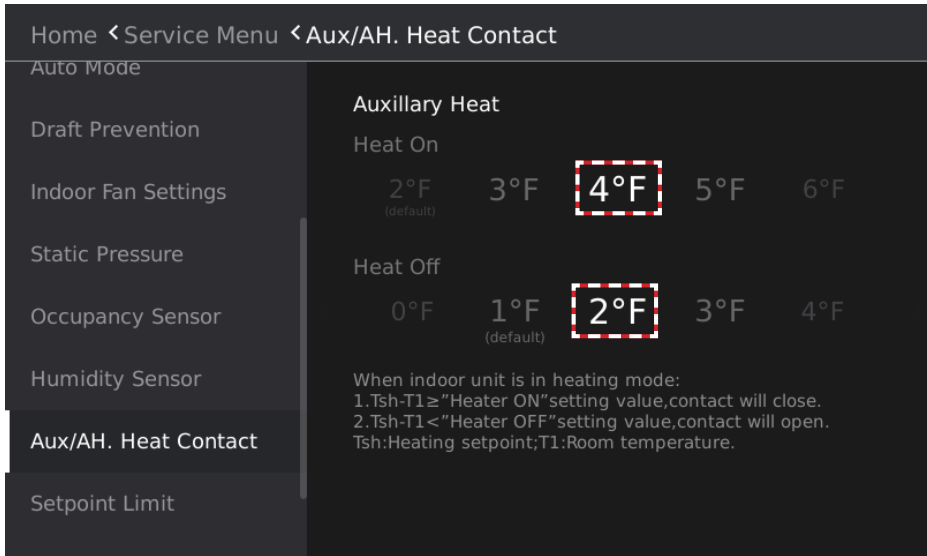

Figure 104. Auxiliary / Alternate Heat ON and OFF Settings

Setpoint Limit Settings

Setup auxiliary and alternate heat source activation from the controller.

1. Tap the Setpoint Limit button to enter the setpoint limit screen.
2. Slide the temperature value below Minimum Cooling Setpoint and select the minimum cooling setpoint. The highlighted value in the middle is the currently selected parameter. After setting the minimum cooling setpoint, the user will be unable to set a value lower than this set value when adjusting the setpoint in Cooling mode and Dry mode, or the cooling setpoint in Auto mode.
3. Slide the temperature value below Maximum Heating Setpoint and select the maximum of the heating setpoint. The highlighted value in the middle is the currently selected parameter. After setting the maximum heating setpoint, the user will be unable to set a value higher than this set value when adjusting the setpoint in Heating mode, or the heating setpoint in Auto mode.

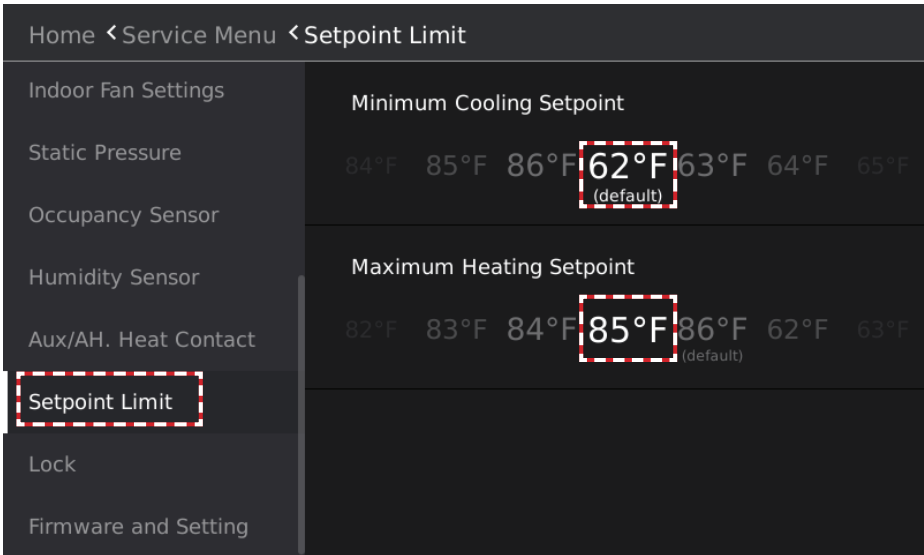

Figure 105. Setpoint Limit Settings

Locking Function Settings

Lock the button operation of the controller to prevent the user from adjusting the controller.

1. Tap the Lock button to access the locking function settings screen.
2. Slide the button on the right of ON/OFF, Mode, Temperature Setpoint, Schedule, Horizontal Louver or Vertical Louver to select whether to lock the parameter.

NOTE - When functionality is locked, the Lock icon will display on the Home screen.

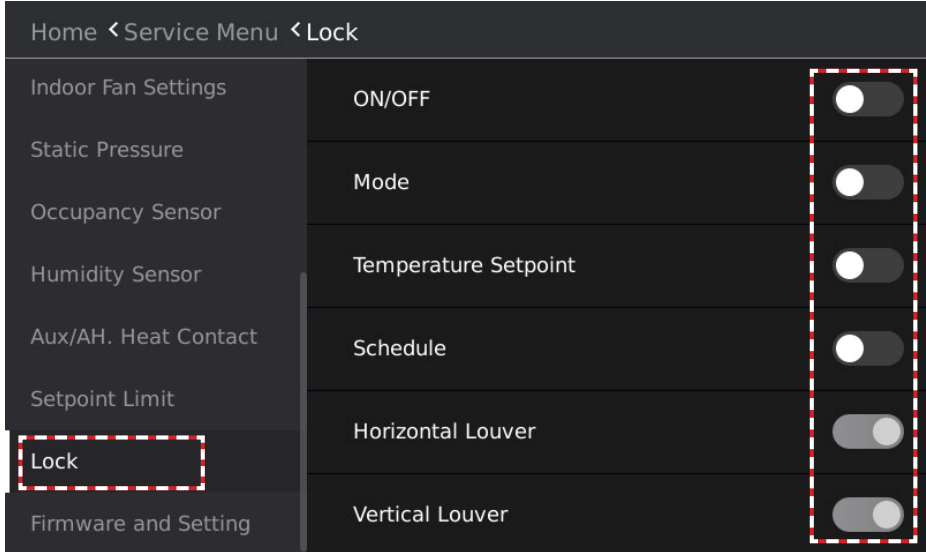

Figure 106. Locking Function Settings

Table 5. Lock Functions

Locking Type	Description
ON/OFF	Lock the ON/OFF button operation of the wired controller.
Mode	Lock the operation mode button operation of the wired controller.
Temperature Setpoint	Lock the set temperature adjustment button operation of the wired controller.
Schedule	Lock the weekly schedule operation parameter.
Horizontal Louver	Lock the vertical swing button operation of the wired controller.
Vertical Louver	Lock the horizontal swing button operation of the wired controller.

Advanced Information

Tap the Advanced Information button to access the indoor unit information query interface.

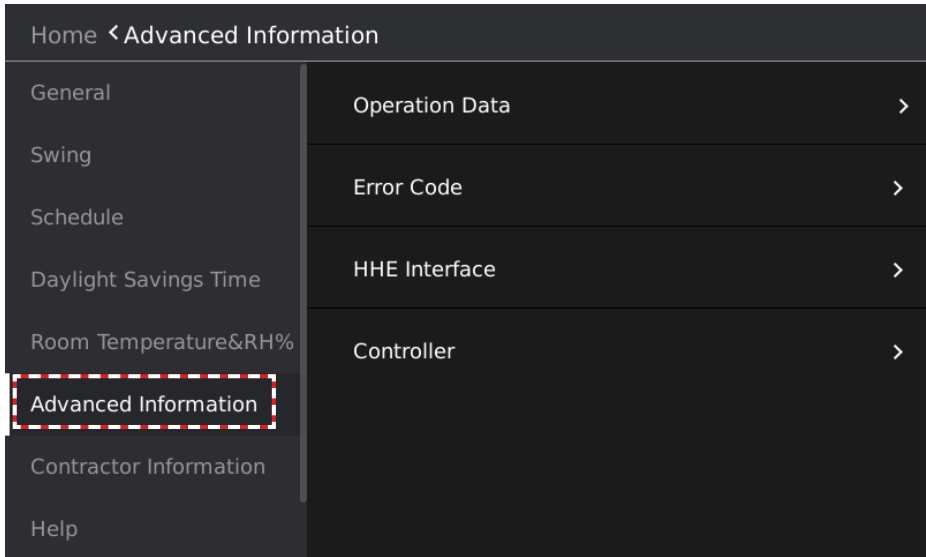

Figure 107. Advanced Information

Device Operation Information Query

Tap the Operation Data button on the screen to enter the system operation information query interface.

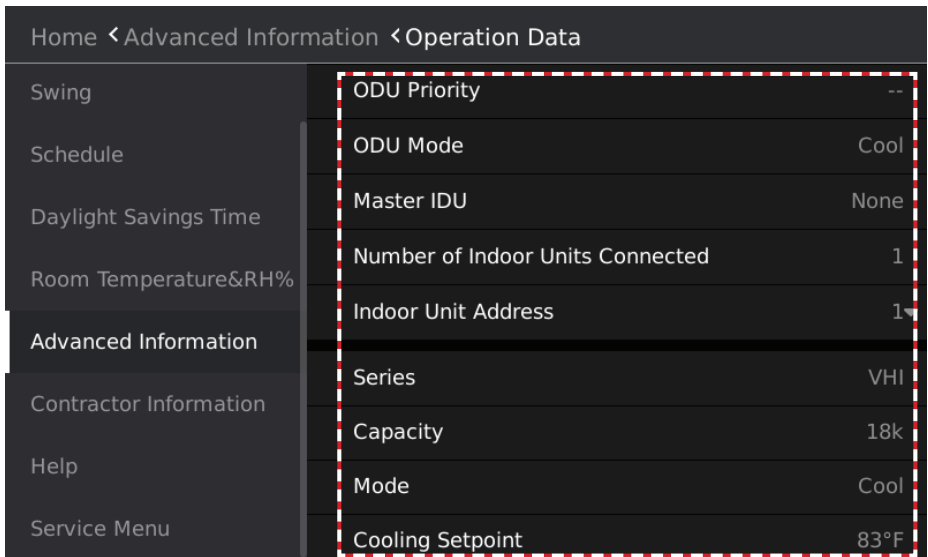
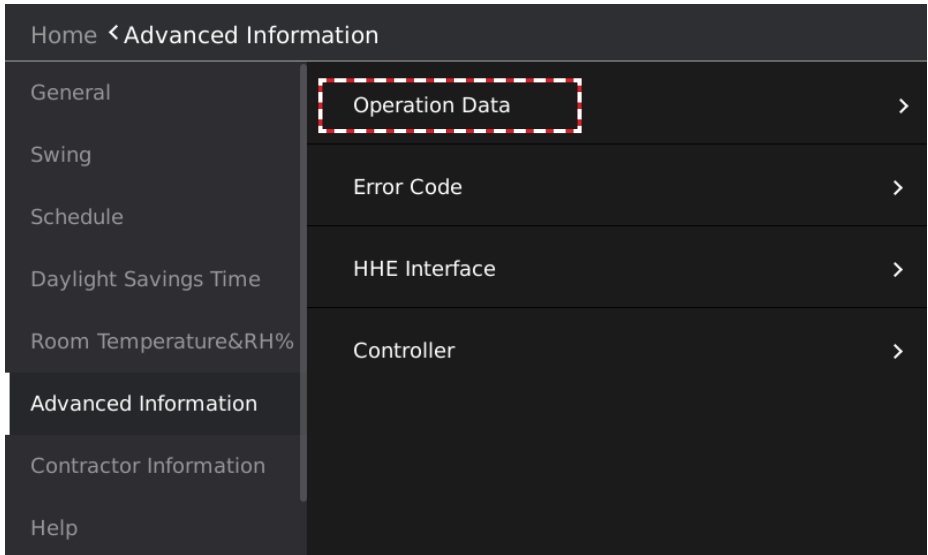

Figure 108. Operation Data Query

Table 6. System Operation Information Queries

Item	Description
ODU Priority	Auto/Cool/Heat/VIP/Heat Only/Cool Only
ODU Mode	Cool/Heat/Fan/Force Cool/OFF
Master IDU	Show VIP indoor unit address; "None" is displayed when there is no VIP Indoor unit.
Indoor quantity	Show the number of connected Indoor Units
Address	Indoor unit address (can be selected if there are multiple indoor unit)
Series	Indoor unit type
Capacity	Indoor unit capacity
Mode	Indoor unit (operation) mode
Cooling setpoint	The cooling setpoint
Heating setpoint	The heating setpoint
T1-In Use	Indoor temperature used by the system
T1-IDU	Temperature value collected by the Indoor Unit's own sensor
T2	Evaporator middle temperature
T2A	Evaporator inlet temperature
T2B	Evaporator outlet temperature
EEV	EXV opening
Fan speed	Fan (operating fan speed) speed
Software version	Indoor Unit software version number.

Table 7. Indoor Unit Types

Indoor Unit Type	Model Number
360° Cassette	V33
Wall-Mounted	VWM
Medium Static Concealed Ducted	VMD
Vertical Air Handler	VVC
High Static Concealed Ducted	VHI
Compact 360° Cassette	V22
Ceiling Floor Convertible	VCF

Device Operation Error History Query

Check the error information of the system to which the wired controller is connected.
Tap the Error Code button to enter the system error information query interface.

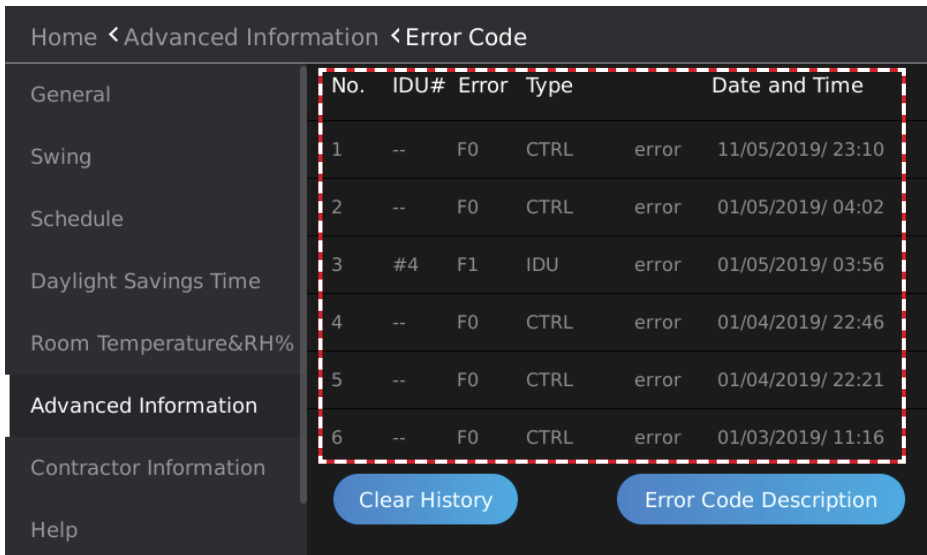
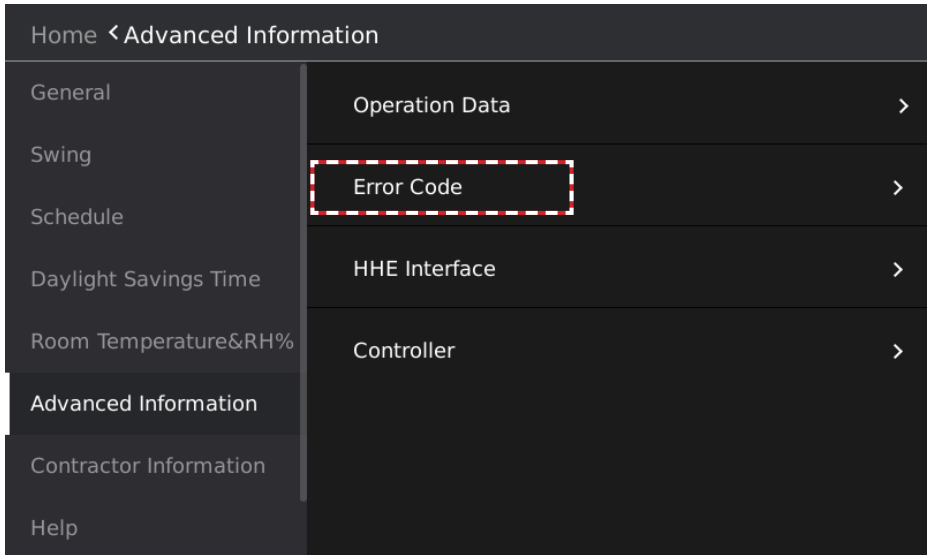

Figure 109. Error Code History Query

Table 8. Error Code Information

Indoor Unit Type	Model Number
No.	Serial number.
IDU#	Address of the faulty indoor unit. If the error is related to the outdoor unit, MS box or controller “- -” is displayed.
Error	Error code number. Use this number to look up the error in the VRF app.
Type	IDU - Indoor unit, ODU - Outdoor unit, CTRL - Controller. Identifies what equipment type is faulty.
Time	Date and time of the error.

Tap the Error Code Description button to enter the error code details screen. Detailed error code analysis and fault finding information is available in the Lennox VRF app.

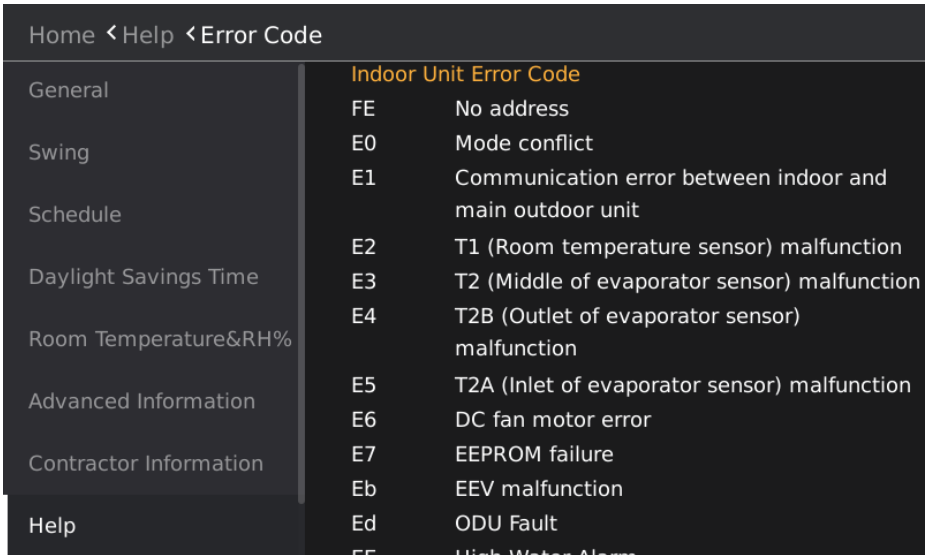
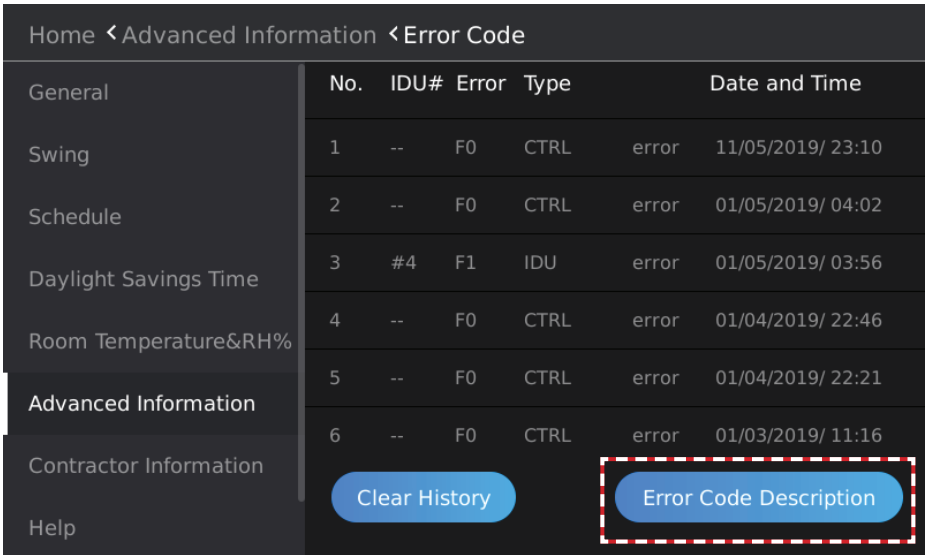

Figure 110. Error Code Descriptions

Tap the Clear History button to delete the error code history from the controller.

The screenshot shows the 'Error Code' history page. On the left is a navigation menu with options: General, Swing, Schedule, Daylight Savings Time, Room Temperature&RH%, Advanced Information, Contractor Information, and Help. The main area displays a table of error records. At the bottom, there are two buttons: 'Clear History' (highlighted with a red dashed box) and 'Error Code Description'.

No.	IDU#	Error	Type	Date and Time
1	--	F0	CTRL	error 11/05/2019/ 23:10
2	--	F0	CTRL	error 01/05/2019/ 04:02
3	#4	F1	IDU	error 01/05/2019/ 03:56
4	--	F0	CTRL	error 01/04/2019/ 22:46
5	--	F0	CTRL	error 01/04/2019/ 22:21
6	--	F0	CTRL	error 01/03/2019/ 11:16

The screenshot shows the same 'Error Code' history page, but with a confirmation dialog box overlaid in the center. The dialog box has a red exclamation mark icon and the text: 'All error code records will be deleted, do you wish to continue?'. Below the text are two buttons: 'NO' and 'YES'. The 'Clear History' button from the previous screenshot is still visible at the bottom, now partially obscured by the dialog box.

Figure 111. Clear Error Code History

HHE Dry Contact Relay Interface Status Query

Tap the HHE Interface button to access the HHE relay query interface.

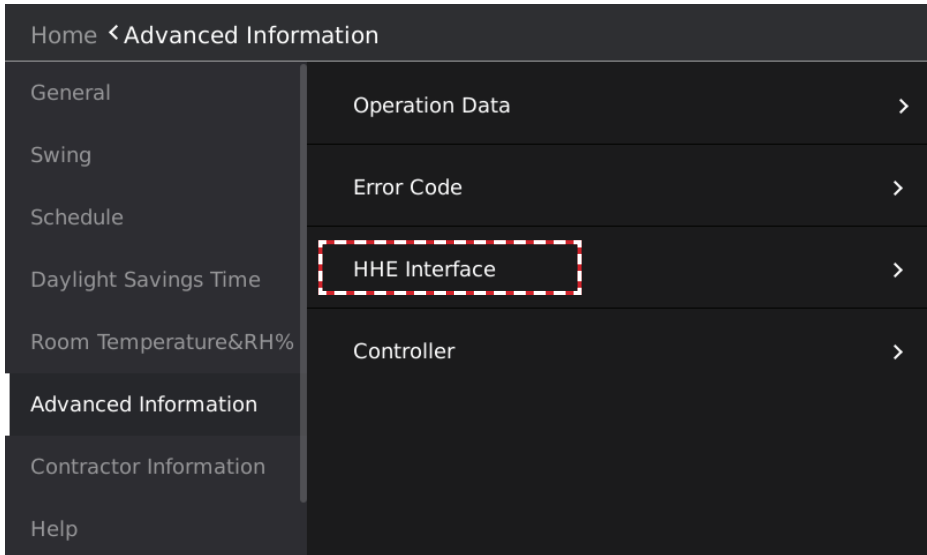

Figure ##. Access HHE Dry Contact Relay Interface

Tap the drop-down button on the right of the Indoor Unit Address, and select an indoor unit address to query the status of dry contacts.

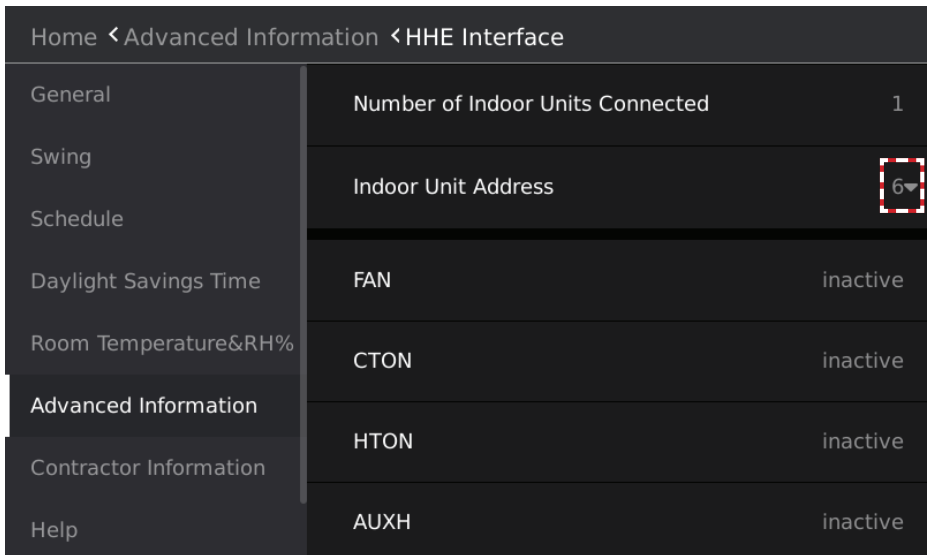

Figure 112. View HHE Dry Contact Relay Information

Controller Information

Tap the Controller button to access the controller information interface.

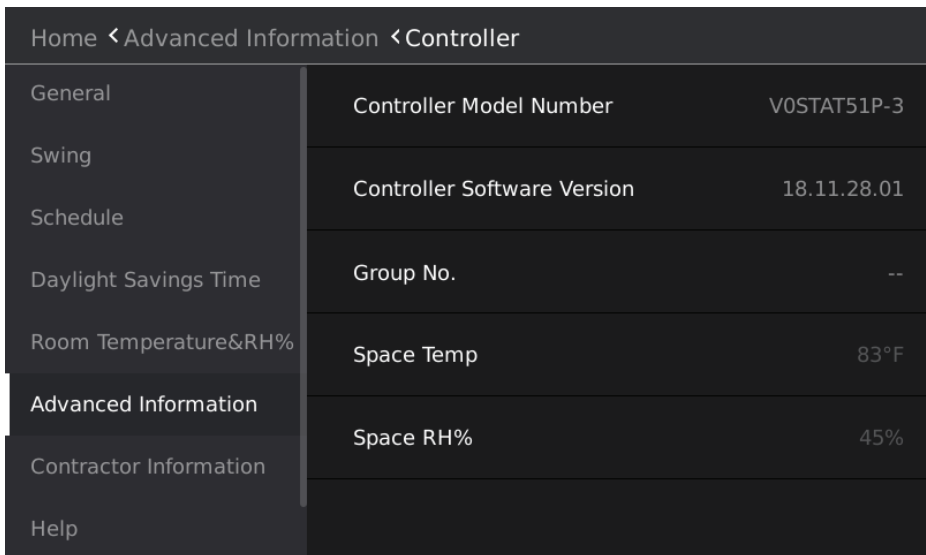
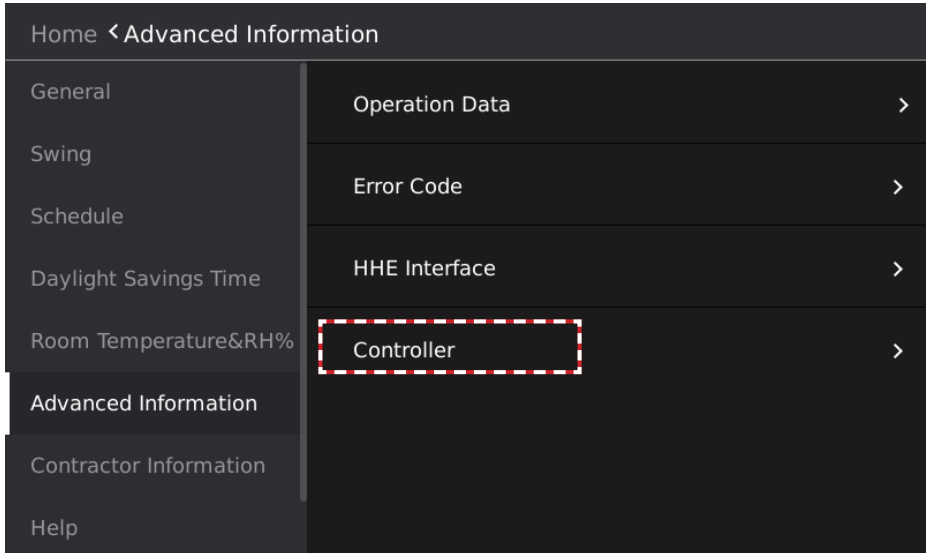

Figure 113. Controller Information

Firmware and Setting Information

Tap the Firmware and Setting button to access the Software Update and Firmware screen.

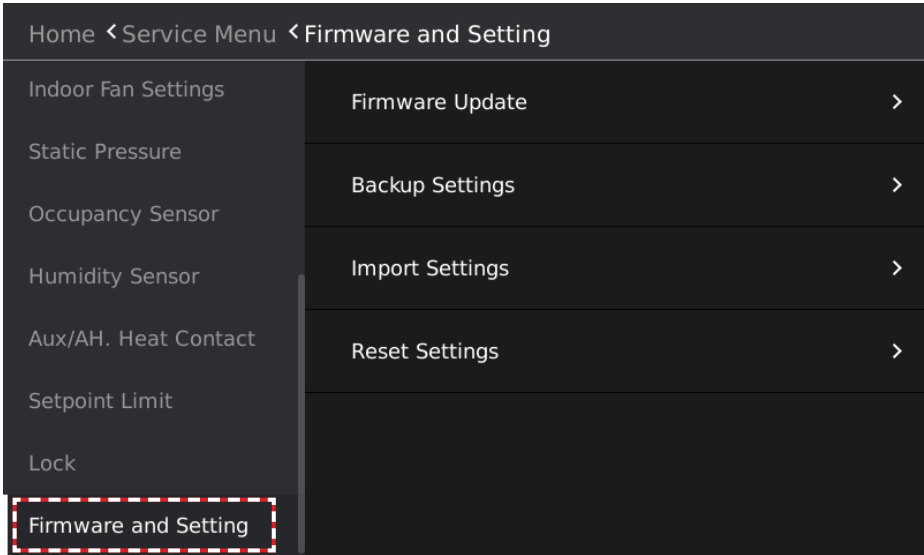

Figure 114. Access Firmware and Settings

CAUTION

DO NOT turn off power to the indoor unit or the controller during the software update process. Damage to indoor unit and controller boards may occur.

IMPORTANT

After initial setup, make a back up copy of the controller settings by following the instructions on page 97. Store the copy on a large capacity flash drive for permanent storage. This ensures the controller can be reset to initial settings if needed.

Software Version

Tap the Firmware and Setting button to access the software update screen.

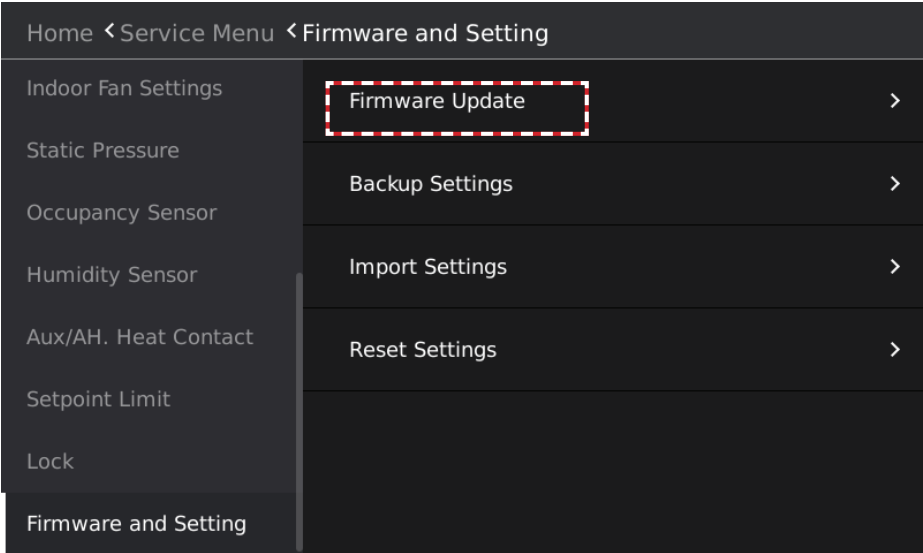

Figure 115. Access Software Update & Version Information

The software update screen displays the current version of the wired controller software.

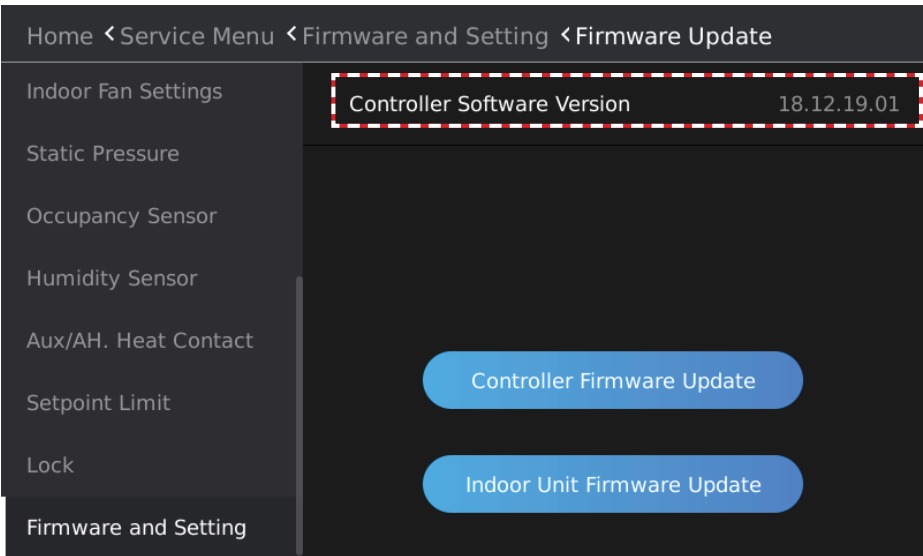

Figure 116. Software Version

Controller Software Update

1. Insert the USB containing the software update files into the USB port on the bottom of the controller.
2. Tap the Controller Firmware Update button, and a list of software installed in the USB device will display.

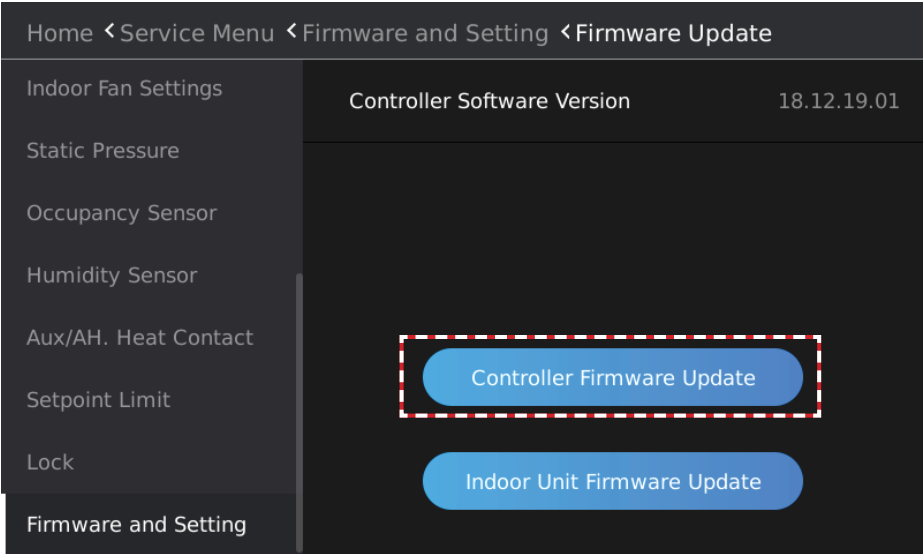

Figure 117. Controller Software Update

3. Select the controller software version number to upgrade.

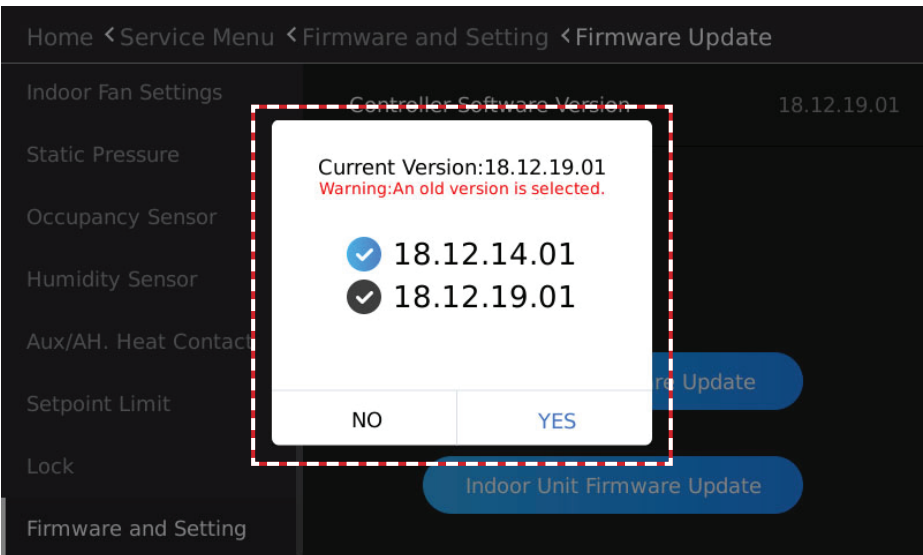

Figure 118. Available Controller Software Update Files

4. Tap YES to upgrade the controller software. Wait for about 10 seconds. Then the Update success pop-up window will display. Or, tap NO to return to the previous screen.

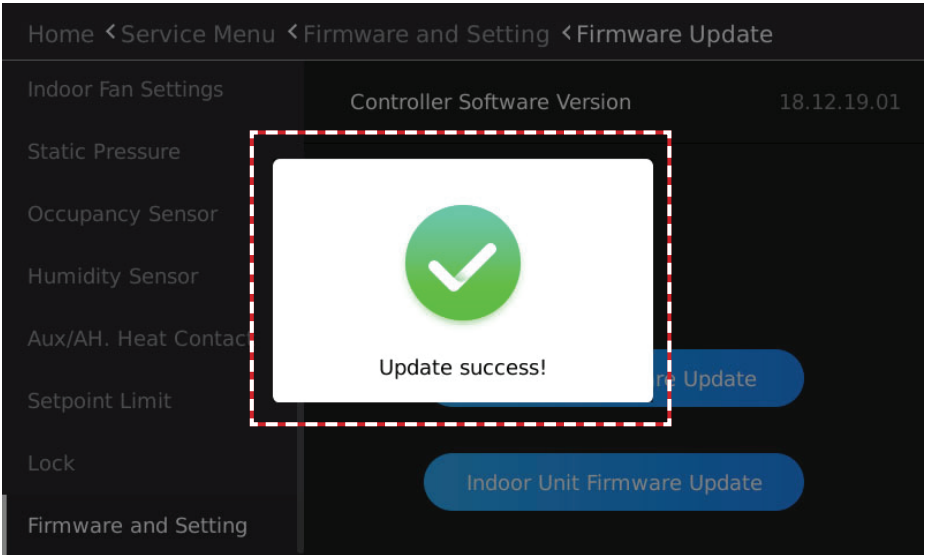

Figure 119. Controller Software Update Success!

5. After the controller software upgrade, the Reboot the system to finish the update prompt box will display. Tap YES to restart the system, or tap NO to return to the previous interface.

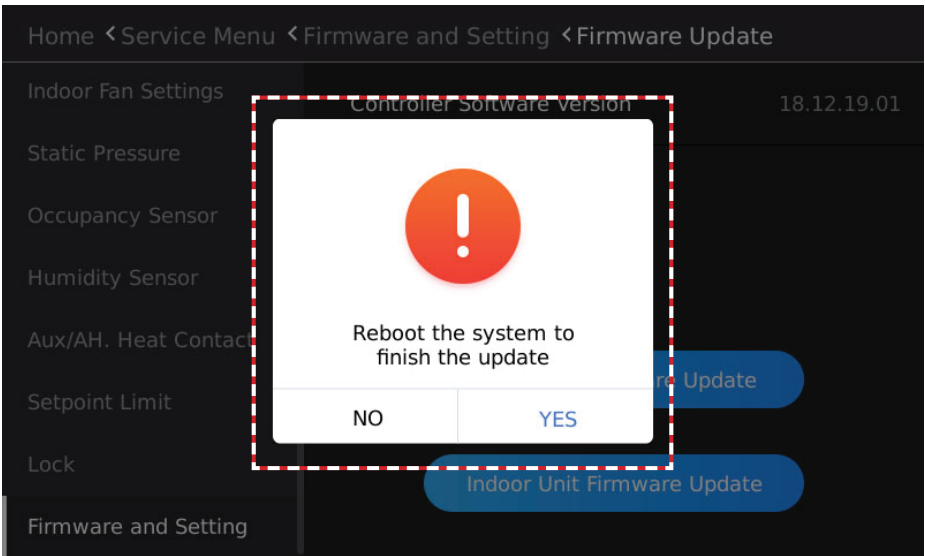

Figure 120. Reboot After Controller Software Update

Indoor Unit Software Update

Update the connected indoor unit software; requires one-to-one connection between indoor unit and controller.

1. Insert the USB containing the software update files into the USB port on the bottom of the controller.

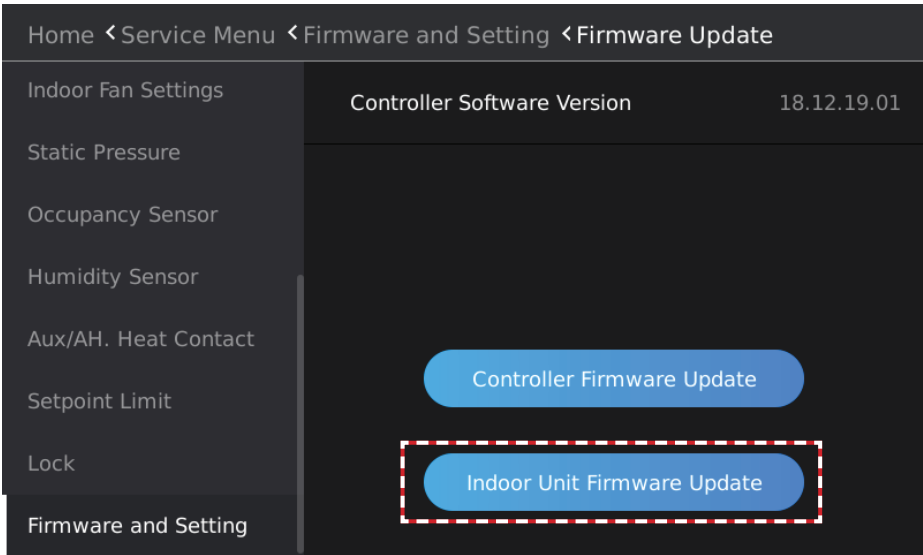

Figure 121. Indoor Unit Software Update

2. Tap the Indoor Unit Firmware Update button, and a list of software installed in the USB device will display.
3. Select the indoor unit software version number to upgrade.

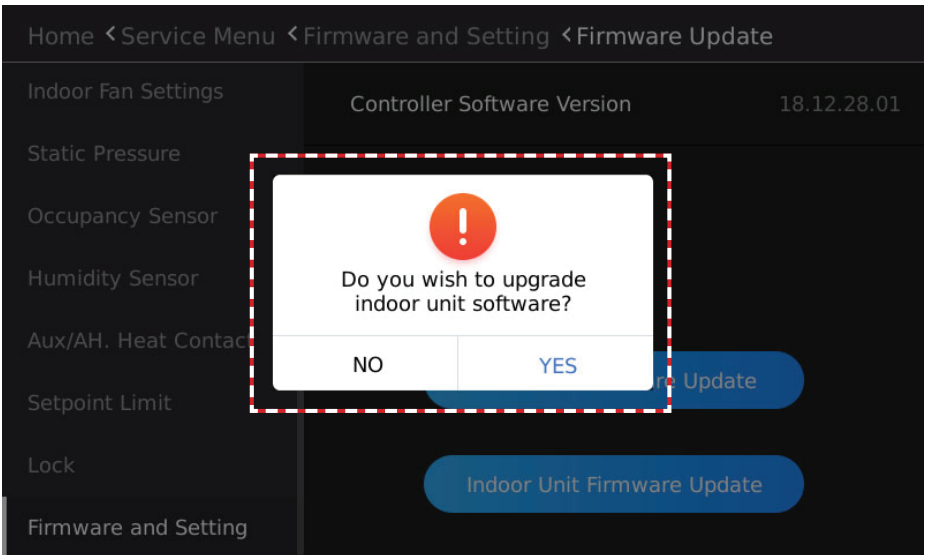
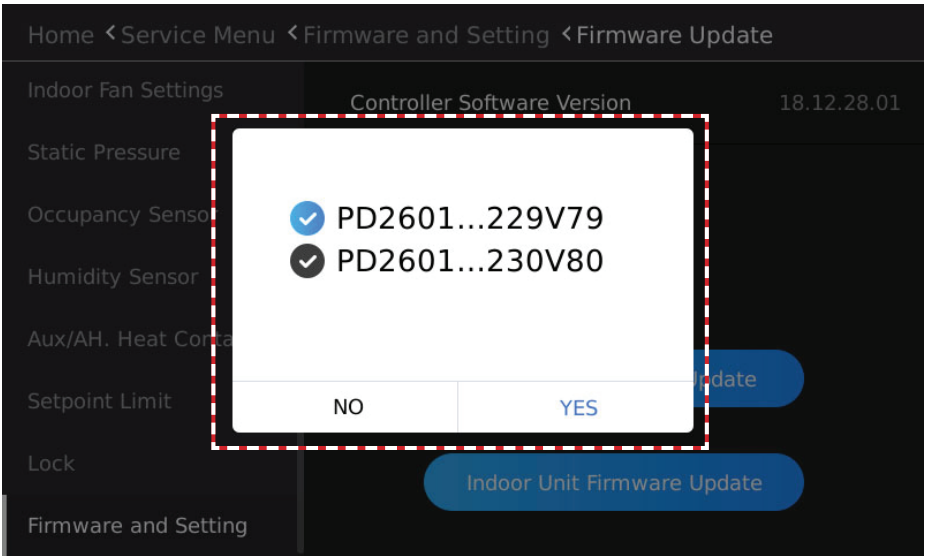

Figure 122. Indoor Unit Software Update File Selection

4. Tap YES, and then the Do you wish to upgrade indoor unit software? pop-up window will display. Or, tap NO to return to the previous screen.
5. The Upgrading software notification will display until the update is complete.

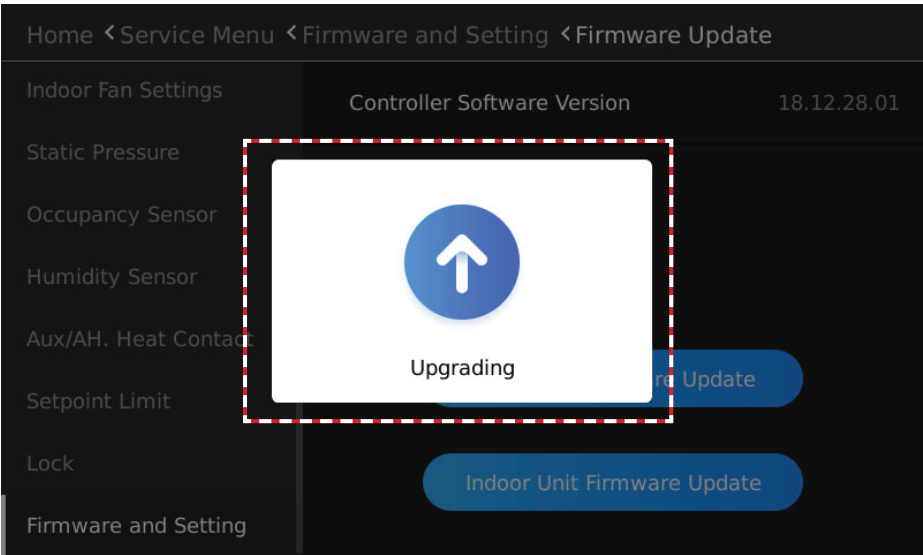

Figure 123. Indoor Unit Software Update In Progress

If the software upgrade is unsuccessful, the notification Indoor unit software upgrade failed. will display.

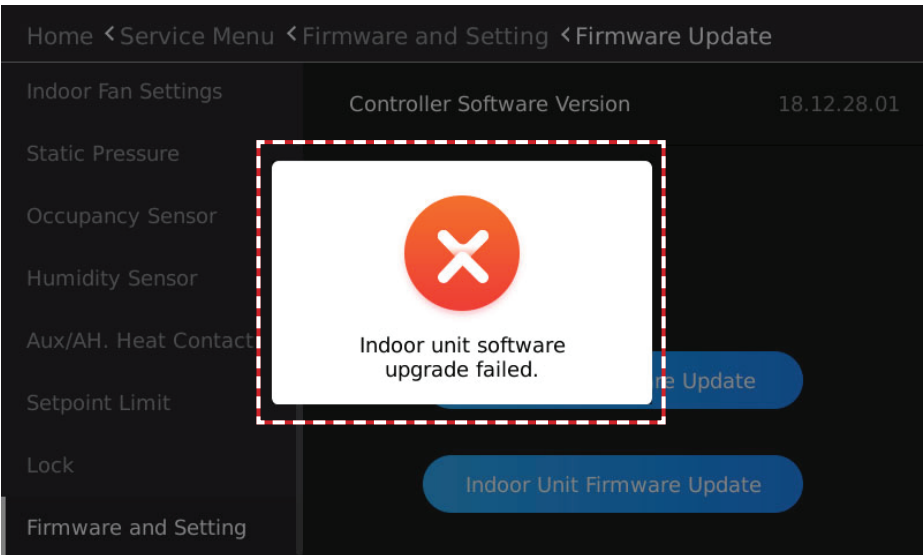

Figure 124. Indoor Unit Software Update Failure

Setting Parameters Backup

Tap the Backup Settings button to export parameters for the general function settings and advanced settings of the wired controller to the connected USB device.

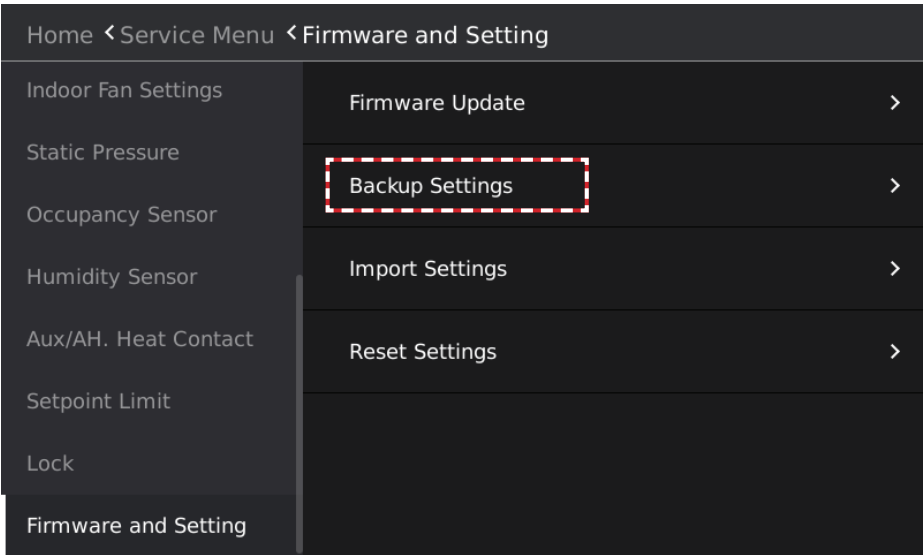

Figure 125. Backup Controller Settings

The Backup Complete pop-up window displays after the setting parameters have been exported.

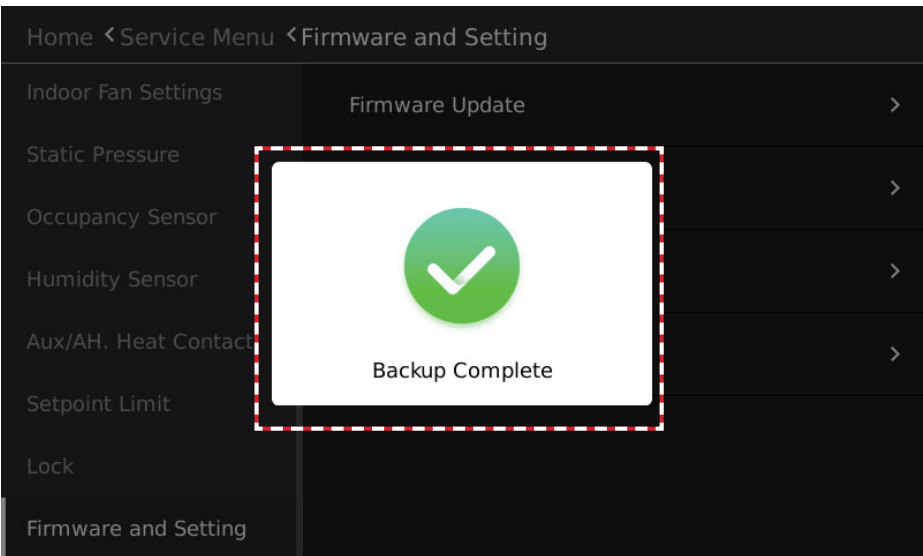

Figure 126. Backup Complete Notification

Setting Parameters Import

Tap the Import Settings button to import parameters for the general function settings and advanced settings of the wired controller from the connected USB device.

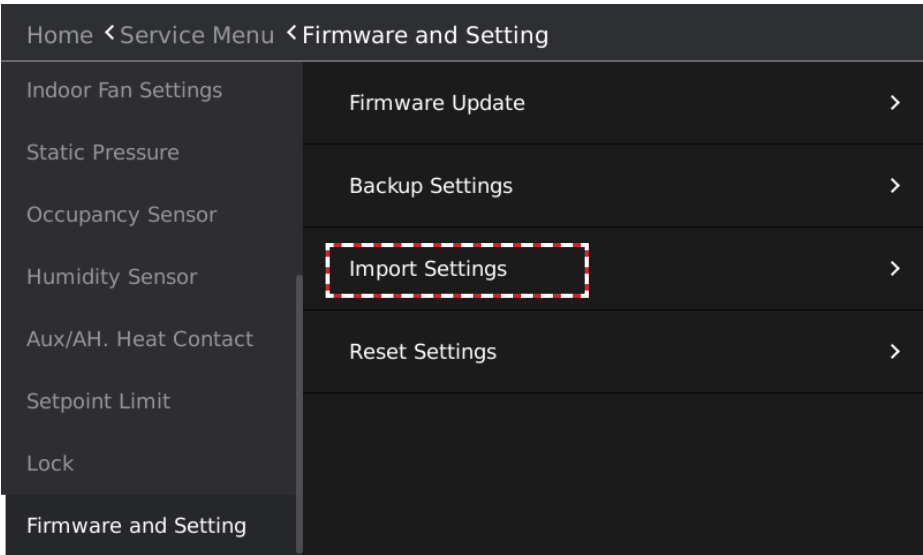

Figure 127. Import Controller Settings

The Settings imported successfully pop-up window displays after the setting parameters have been exported.

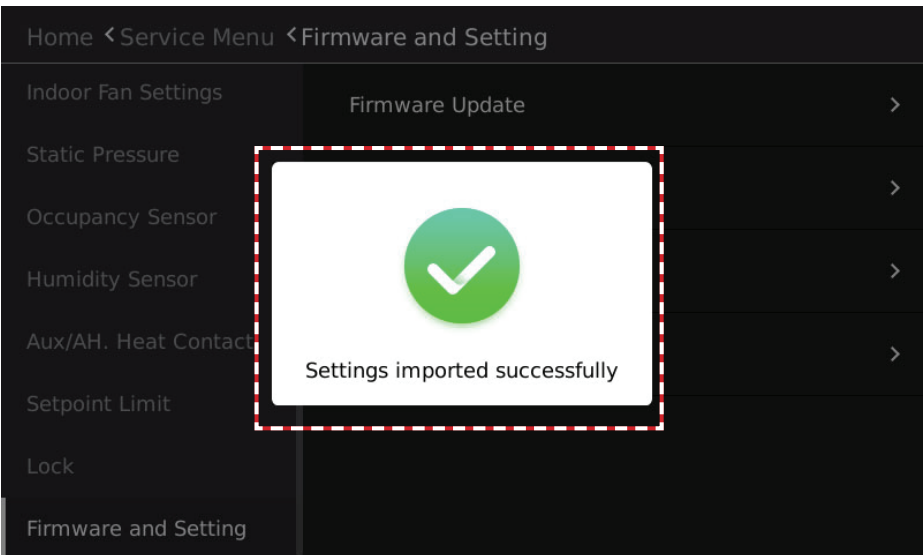

Figure 128. Import Successful Notification

Reset Settings

Tap the Reset Settings button to reset the settings of the wired controller to factory default.

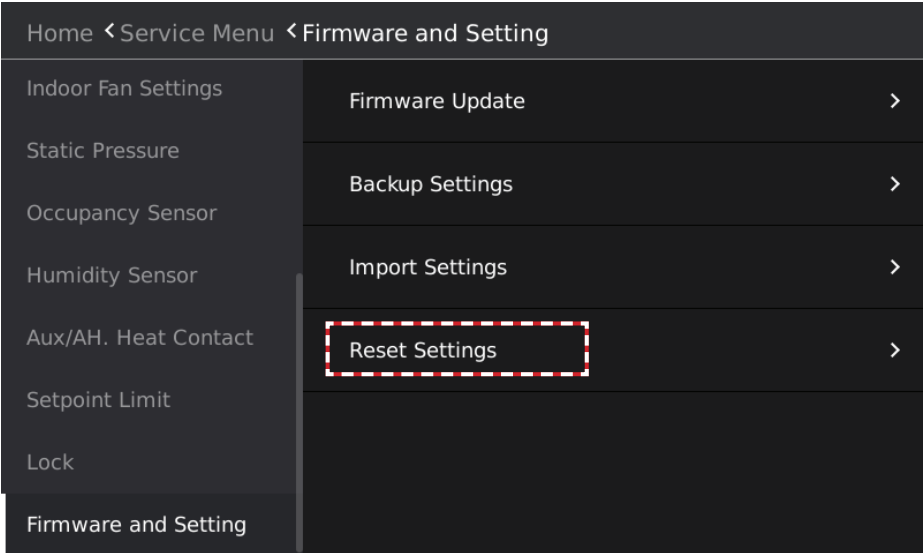

Figure 129. Reset Controller to Factory Settings

A prompt reading “All settings will be reset. Do you wish to continue?” will display.

Tap YES to restore all settings of the wired controller to factory settings, or tap NO to return to the previous screen.

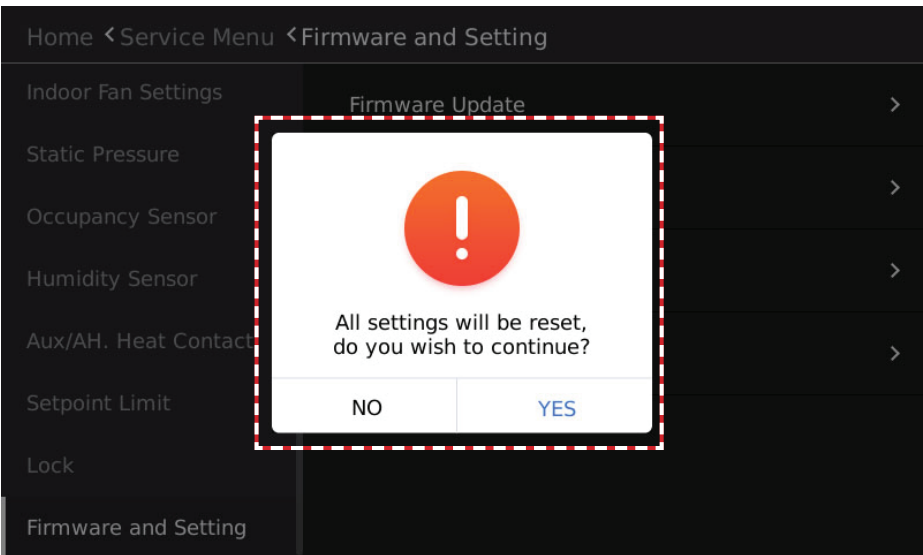

Figure 130. Reset to Factory Settings Confirmation

Help

Get On-screen Help

- Tap the Help button to access the help screens.
- Tap the Home Page Instruction button to access the icon description screen.
- Tap the Error Code button to access the error code description screen.

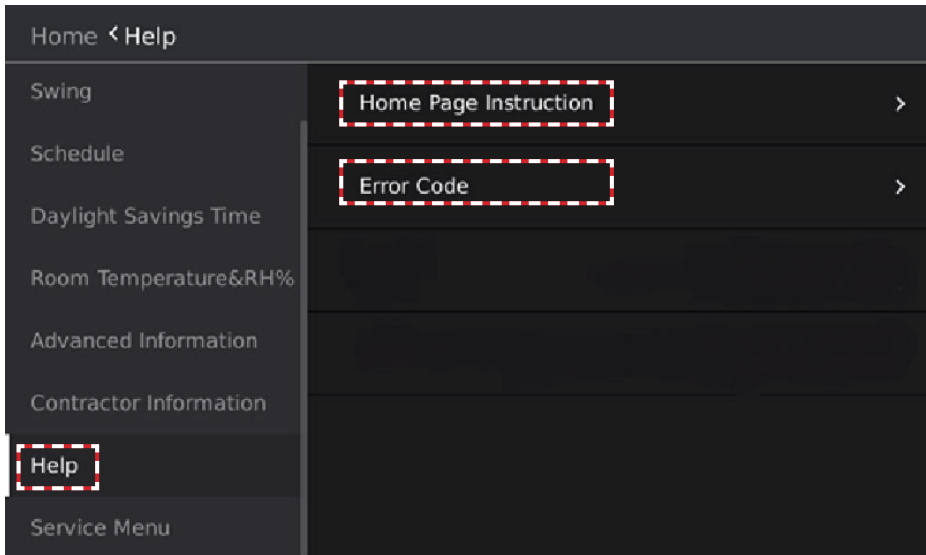

Figure 131. On-Screen Help



Warning:

Please note that changes or modifications of this product is not expressly approved by the party responsible for compliance could void the user's authority to operate the equipment.

Statement of digital devices:

NOTE: This equipment has been tested and found to comply with the limits for a Class B digital device, pursuant to Part 15 of the FCC Rules. These limits are designed to provide reasonable protection against harmful interference in a residential installation. This equipment generates, uses and can radiate radio frequency energy and, if not installed and used in accordance with the instructions, may cause harmful interference to radio communications. However, there is no guarantee that interference will not occur in a particular installation. If this equipment does cause harmful interference to radio or television reception, which can be determined by turning the equipment off and on, the user is encouraged to try to correct the interference by one or more of the following measures:

- Reorient or relocate the receiving antenna.
- Increase the separation between the equipment and receiver.
- Connect the equipment into an outlet on a circuit different from that to which the receiver is connected.
- Consult the dealer or an experienced radio/TV technician for help.

Lennox Information:

This device complies with Part 15 of the FCC Rules. Operation is subject to the following two conditions:

- (1) this device may not cause harmful interference, and (2) this device must accept any interference received, including interference that may cause undesired operation.

Lennox Industries Inc.

Address: 2140 Lake Park Blvd, Richardson, TX 75080, USA

Phone: 1-844-438-8731

Technical Support

1-844-GET-VRF1

(1-844-438-8731)

vrftechsupport@lennoxind.com

www.LennoxVRF.com

Download the app from the Apple App Store or the Google Play store.

