



HEALTHY CLIMATE® DUAL HOOD KIT

INSTALLATION INSTRUCTIONS FOR THE HEALTHY CLIMATE® DUAL HOOD KIT (Y3813) USED WITH HRV / ERV UNITS

Healthy Climate® Dual Hood Kit (Y3813)

Included in this kit:

- Hood Assembly
- Foam Gasket
- Duct Splitter
- Duct Insulator
(2 pieces)
- Retainer Screw
Assembly
- Nylon Cable Tie
- Screen



Field provided parts

In addition to the Dual Hood kit components, the following items are required (field provided):

- Waterproof sealant (silicone).
- (4) Screws with countersunk heads:
#8 x 1-1/2" wood screws OR,
3/16" x 1-1/2" concrete screws.

⚠ IMPORTANT

Contact your local building authority before installation of the Dual Hood kit to verify compliance with local building codes.

⚠ CAUTION

Apply sealant per instructions on next page or leakage and condensation may occur.

⚠ IMPORTANT

Insulate the Fresh Air Supply and Stale Air Exhaust ductwork back to the HRV/ERV unit.

Intake/Exhaust Requirements

- Minimum 6' (2m) away from dryer vents, furnace exhaust (medium or high efficiency furnaces), driveways, oil fill pipes, gas meters, or garbage containers.
- At least 18" (457 mm) above the ground, or above the depth of expected snow accumulation.
- At least 3' (1m) from the corner of the building.
- Do not locate in a garage, attic or crawl space.

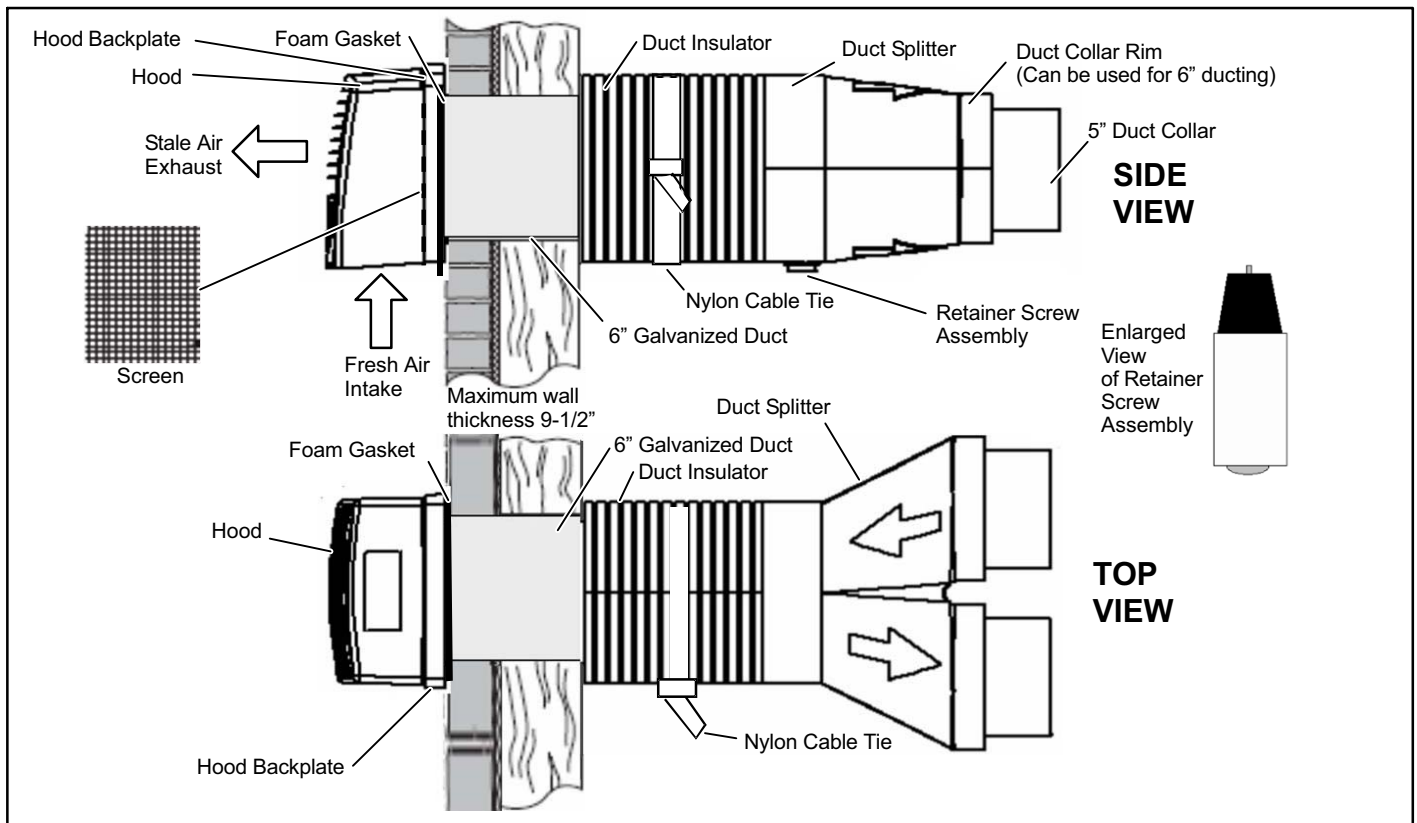

Installing Dual Hood Kit

Step 1

- A Cut a 6" diameter hole in the exterior of wall of the building.
- B The top of the hole should be a minimum of 1" from the bottom of the floor above (if applicable).

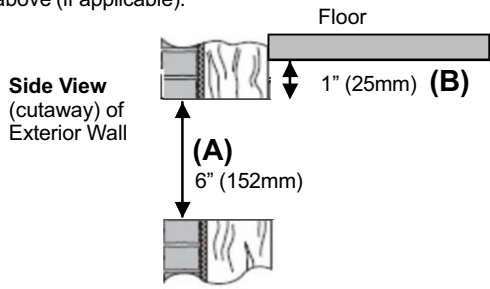

Step 2

- A Remove the hood cover from the backplate.
- B Slide the foam gasket around the 6" galvanized duct with the white side of the gasket towards the backplate. Align and insert the rounded side of the foam gasket into the rounded side of the backplate.

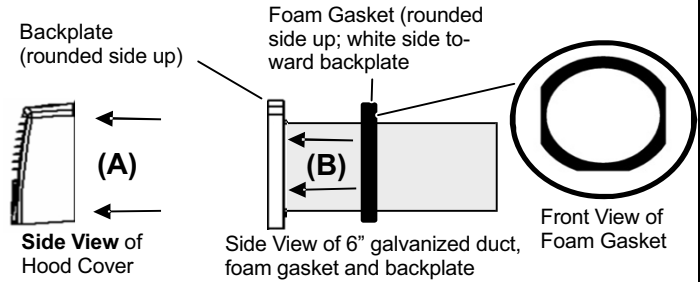

Step 3

- A Insert the 6" galvanized duct through the hole cut in the exterior wall. Slide in until the backplate is flush with the exterior wall (curved side up).
- B Level the backplate and drill 4 holes in the exterior wall.
- C Seal the Backplate with exterior weatherproof sealant and fasten it to the wall using field provided screws.

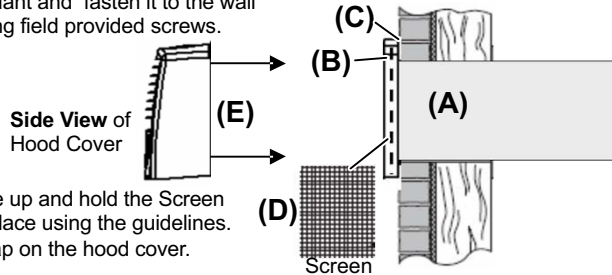

- D Line up and hold the Screen in place using the guidelines.
- E Snap on the hood cover.

Step 4

- For 5" Ducting, attach the two insulated 5" ducts from the unit over the 5" Duct Collar (A). Secure the insulation to the 6" Duct Splitter Collar Rim (B).

- For 6" Ducting, secure the insulated 6" Ducts from the unit over the 6" Duct Splitter Collar Rim (B).

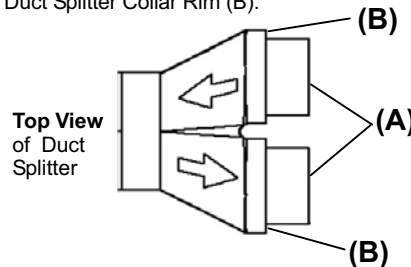

NOTE - Tape the Duct to the Duct Splitter Collar; do not drill.

Step 5

Apply silicone generously:

- A Around the 6" galvanized duct at the interior wall.
- B On the groove of the internal divider located inside the 6" galvanized duct.
- C Around the outer edge of the 6" galvanized duct.

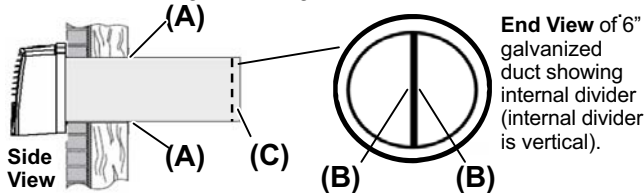

End View of 6" galvanized duct showing internal divider (internal divider is vertical).

Step 6

- A Attach the duct splitter over the 6" galvanized duct. Be sure the pieces align with the holes located in the underside of the duct splitter and 6" galvanized duct.
- B Insert and attach the Retainer Screw Assembly until it seats in the pre-punched hole in the galvanized pipe. The nylon should be flush with the foam. Screw until secure (3 to 4 turns).

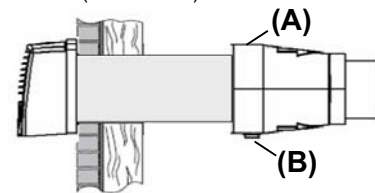

Step 7

- A Measure the distance from the interior wall to the duct splitter.
- B Line up the 2 halves of the duct insulator to fit together.
- C Use a blade knife to cut both halves of the duct insulator to the measured distance.

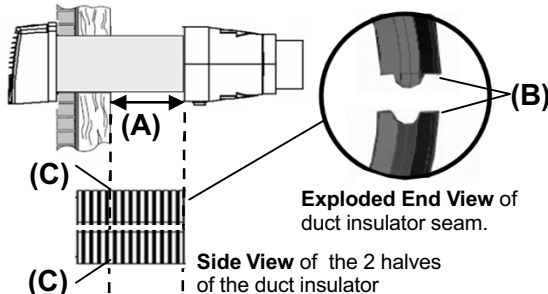

Exploded End View of duct insulator seam.

Side View of the 2 halves of the duct insulator

Step 8

- A Silicone the concave sides of the duct insulator.
- B Silicone both ends of the duct insulator.
- C Align the cut ends of the duct insulators towards the exterior wall and wrap the 2 halves of the insulator around the exposed 6" galvanized duct.
- D Secure the duct insulator with the Nylon Cable Tie.

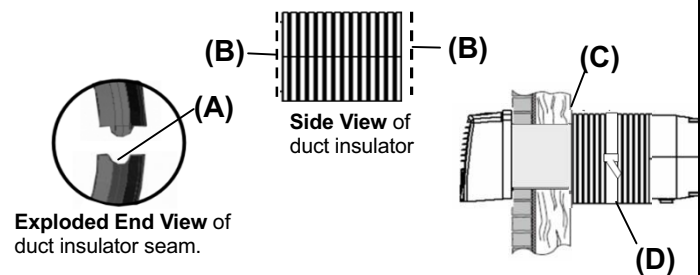

Exploded End View of duct insulator seam.