



538430-01

01

02

03

04

05

06

07

08

09

10

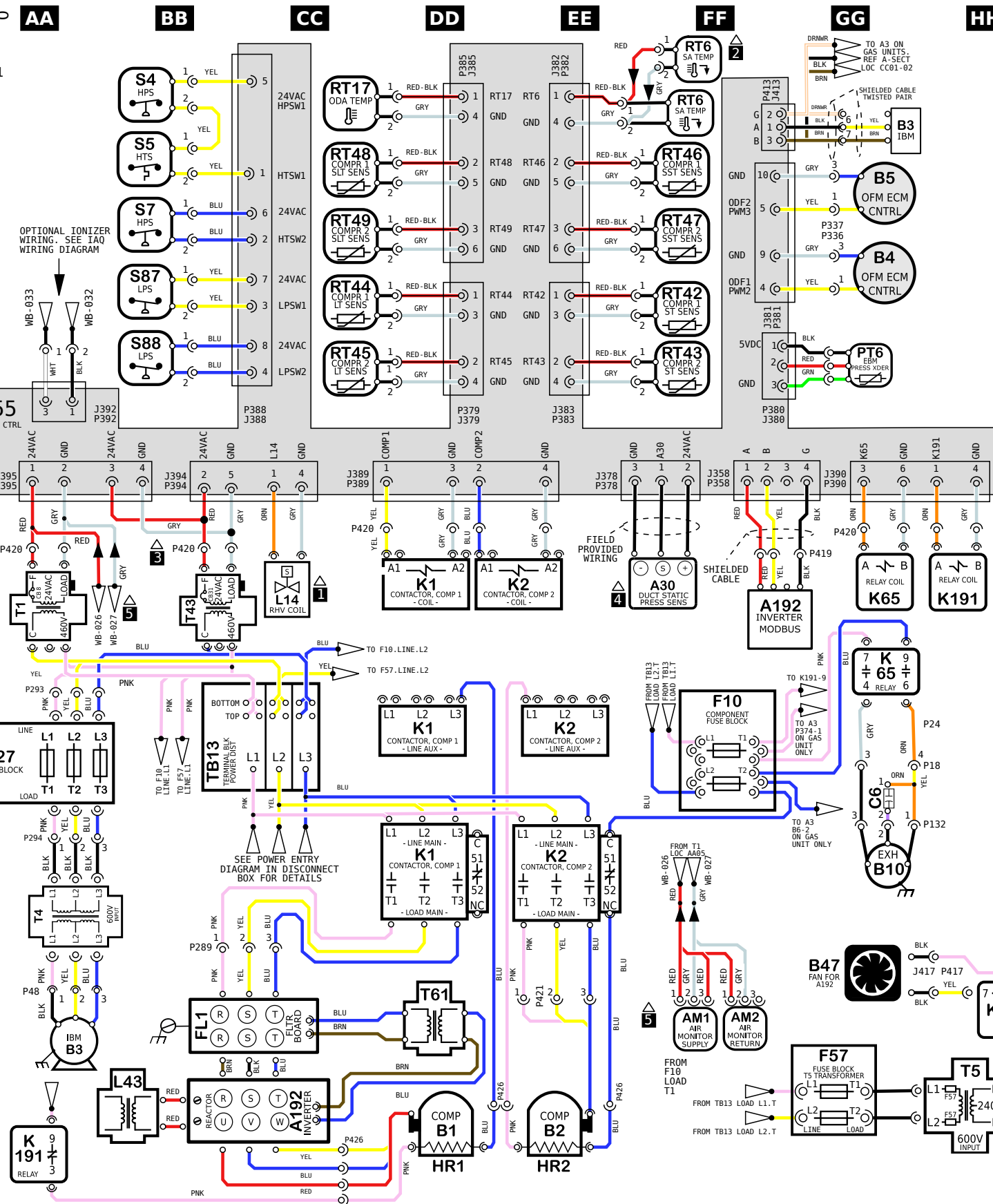

LOCATION	COMPONENT DESCRIPTION
EE/FF05	A30 SENSOR, DUCT STATIC PRESSURE
FF05, BB/CC09	A192 INVERTER, COMPRESSOR 1
DD/EE10	B1, B2 COMPRESSOR 1, 2
AA09B, GG01	B3 MOTOR, BLOWER
GG02, KK09	B4, B5 MOTOR, OUTDOOR FAN 1, 2
GG07	B10 MOTOR, EXHAUST FAN 1
GG08	B47 MOTOR, COOLING FAN FOR A192
GG07	C6 CAPACITOR, EXHAUST FAN 1
FF05	F10 FUSE, COMPONENT
GG09	F57 FUSE, T5 TRANSFORMER
AA06	F27 FUSE, T4 TRANSFORMER
BB/CC08/09	FL1 FILTER BOARD
DD/EE10	HR1, HR2 HEATER, COMPRESSOR 1, 2
DD/EE05, 06, 07	K1, K2 CONTACTOR, COMPRESSOR 1, 2
GG05/06	K65 RELAY, EXHAUST FAN 1
AA09, HH05/08	K191 RELAY, CRANKCASE HEATER 1
CC05	L14 VALVE, SOLENOID, REHEAT COIL 1, 2
BB09	L43 REACTOR INVERTER
GG03	PT6 PRESSURE TRANSDUCER, EBM MOTOR
FF01	RT6 SENSOR, A55 DISCHARGE (IMC)
CC01	RT17 SENSOR, OUTSIDE AIR TEMP
FF03	RT42, RT43 SENSOR, SUCTION TEMP., COMP 1, 2
CC03	RT44, RT45 SENSOR, LIQUID TEMP., COMP 1, 2
FF02	RT46, RT47 SENSOR, SAT. SUCT TEMP., COMP 1, 2
CC02	RT48, RT49 SENSOR, SAT. LIQUID TEMP., COMP 1, 2
BB01/02	S4, S7 LIMIT, HI PRESS. SWITCH, COMP 1, 2
BB01	S5 LIMIT, HI TEMP. SWITCH, COMP 1
BB02/03	S87, S88 SWITCH, LOW PRESS., COMP. 1, 2
AA05	T1 TRANSFORMER, CONTROL
AA07/08	T4 TRANSFORMER, BLOWER MOTOR
HH09	T5 TRANSFORMER, OUTDOOR FAN MOTOR
BB05	T43 TRANSFORMER, CONTACTOR
DD09	T61 TRANSFORMER, INV INTERNAL POWER
AA07	TB13 TERMINAL STRIP, POWER DISTRIBUTION

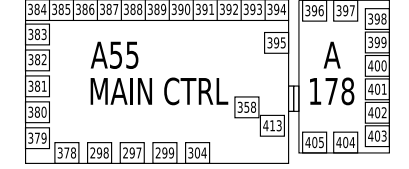

- NOTES**
- 1 ONLY ON UNITS WITH HUMIDITROL OPTION
 - 2 FOR REMOTE LOCATION OF RT6, ADD THE EXTENSION HARNESS
 - 3 MOVE WIRES FROM 240 TO 208 TAP ON TRANSFORMER FOR 208 VOLT APPLICATIONS
 - 4 USED ON VAV UNITS ONLY
 - 5 IAQ SENSORS OPTIONAL
- ▲ DENOTES OPTIONAL COMPONENTS AND WIRING

WARNING
DISCONNECT ALL POWER BEFORE SERVICING.
ELECTRIC SHOCK HAZARD, CAN CAUSE INJURY OR DEATH. UNIT MUST BE GROUNDED IN ACCORDANCE WITH NATIONAL AND LOCAL CODES.
FOR USE WITH COPPER CONDUCTORS ONLY. REFER TO UNIT RATING PLATE FOR MINIMUM CIRCUIT AMPACITY AND MAXIMUM OVERCURRENT PROTECTION SIZE.
IF ANY WIRE IN THIS APPLIANCE IS REPLACED, IT MUST BE REPLACED WITH WIRE OF LIKE SIZE, RATING AND INSULATION THICKNESS.

Product: LGM ALL UNIT J VOLT CONV KIT
Cooling Diagram with Higher SCCR

Voltage: 575/3/60 (J)
Supersedes: N/A
Form No: 538430-01 Rev: 0

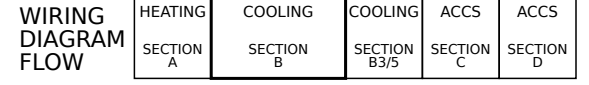

REV	EC NO.	DATE	BY	APVD	REVISION NOTE
0	CN-012439	12-06-2023	FEP	MCF	ORIGINATED AT PD&R CARROLLTON, TX

© 2019



538430-01

01

02

03

04

05

06

07

08

09

10

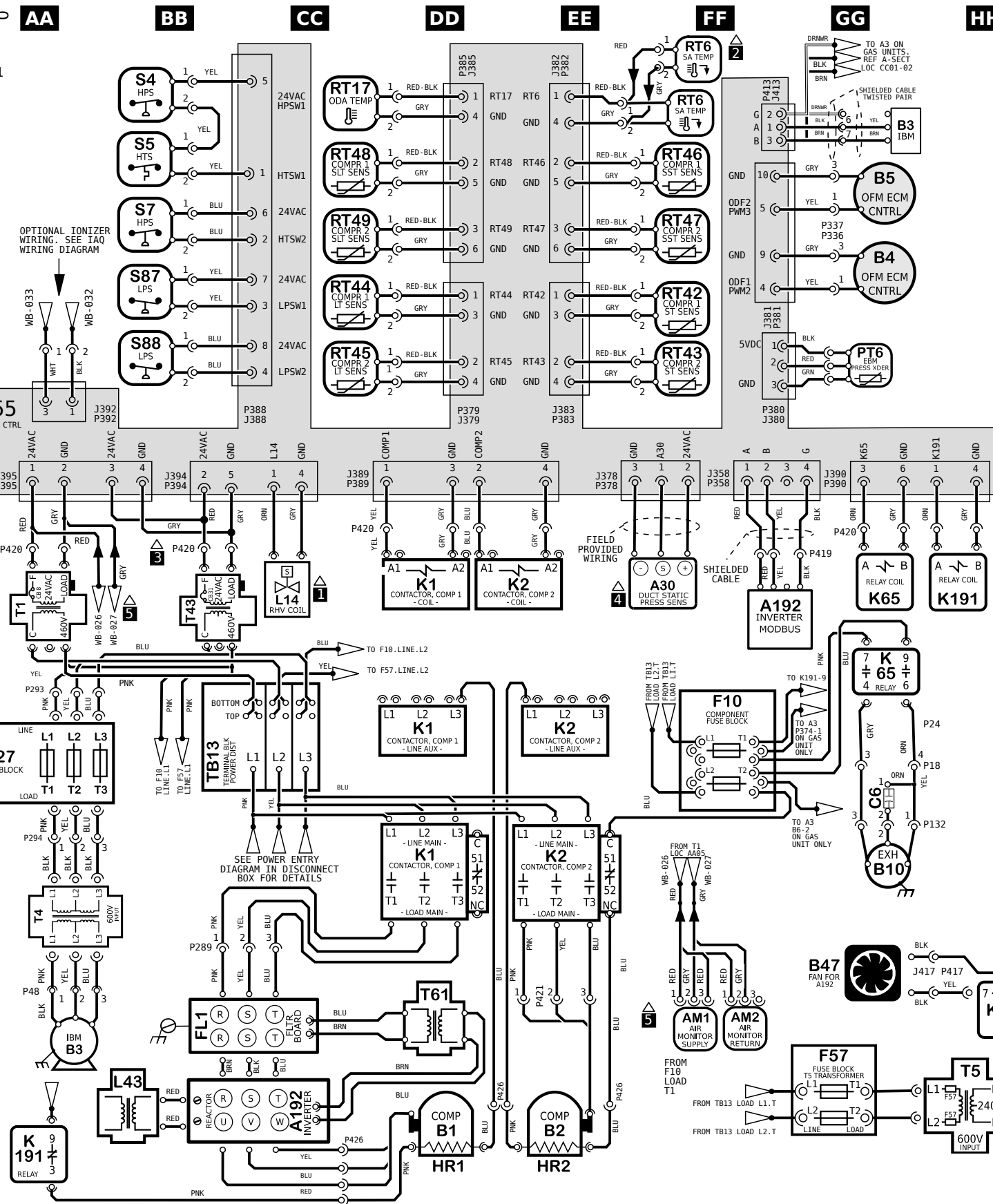

KEY LIST		
LOCATION	COMPONENT DESCRIPTION	
EE/FF05	A30	SENSOR, DUCT STATIC PRESSURE
FF05, BB/CC09	A192	INVERTER, COMPRESSOR 1
DD/EE10	B1, B2	COMPRESSOR 1, 2
AA09B, GG01	B3	MOTOR, BLOWER
GG02, KK09	B4, B5	MOTOR, OUTDOOR FAN 1, 2
GG07	B10	MOTOR, EXHAUST FAN 1
GG08	B47	MOTOR, COOLING FAN FOR A192
GG07	C6	CAPACITOR, EXHAUST FAN 1
FF05	F10	FUSE, COMPONENT
GG09	F57	FUSE, T5 TRANSFORMER
AA06	F27	FUSE, T4 TRANSFORMER
BB/CC08/09	FL1	FILTER BOARD
DD/EE10	HR1, HR2	HEATER, COMPRESSOR 1, 2
DD/EE05, 08, 07	K1, K2	CONTACTOR, COMPRESSOR 1, 2
GG05/06	K65	RELAY, EXHAUST FAN 1
AA09, HH05/08	K191	RELAY, CRANKCASE HEATER 1
CC05	L14	VALVE, SOLENOID, REHEAT COIL 1, 2
BB09	L43	REACTOR INVERTER
GG03	PT6	PRESSURE TRANSDUCER, EBM MOTOR
FF01	RT6	SENSOR, A55 DISCHARGE (IMC)
CC01	RT17	SENSOR, OUTSIDE AIR TEMP
FF03	RT42, RT43	SENSOR, SUCTION TEMP., COMP 1, 2
CC03	RT44, RT45	SENSOR, LIQUID TEMP., COMP 1, 2
FF02	RT46, RT47	SENSOR, SAT. SUCT TEMP., COMP 1, 2
CC02	RT48, RT49	SENSOR, SAT. LIQUID TEMP., COMP 1, 2
BB01/02	S4, S7	LIMIT, HI PRESS. SWITCH, COMP 1, 2
BB01	S5	LIMIT, HI TEMP. SWITCH, COMP 1
BB02/03	S87, S88	SWITCH, LOW PRESS., COMP. 1, 2
AA05	T1	TRANSFORMER, CONTROL
AA07/08	T4	TRANSFORMER, BLOWER MOTOR
HH09	T5	TRANSFORMER, OUTDOOR FAN MOTOR
BB05	T43	TRANSFORMER, CONTACTOR
DD09	T61	TRANSFORMER, INV INTERNAL POWER
AA07	TB13	TERMINAL STRIP, POWER DISTRIBUTION

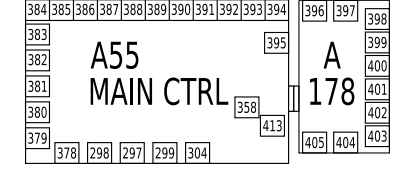

- NOTES**
- 1 ONLY ON UNITS WITH HUMIDITROL OPTION
 - 2 FOR REMOTE LOCATION OF RT6, ADD THE EXTENSION HARNESS
 - 3 MOVE WIRES FROM 240 TO 208 TAP ON TRANSFORMER FOR 208 VOLT APPLICATIONS
 - 4 USED ON VAV UNITS ONLY
 - 5 IAQ SENSORS OPTIONAL

WARNING
 DISCONNECT ALL POWER BEFORE SERVICING.
 ELECTRIC SHOCK HAZARD, CAN CAUSE INJURY OR DEATH. UNIT MUST BE GROUNDED IN ACCORDANCE WITH NATIONAL AND LOCAL CODES.
 FOR USE WITH COPPER CONDUCTORS ONLY. REFER TO UNIT RATING PLATE FOR MINIMUM CIRCUIT AMPACITY AND MAXIMUM OVERCURRENT PROTECTION SIZE.
 IF ANY WIRE IN THIS APPLIANCE IS REPLACED, IT MUST BE REPLACED WITH WIRE OF LIKE SIZE, RATING AND INSULATION THICKNESS.

← DENOTES OPTIONAL COMPONENTS AND WIRING

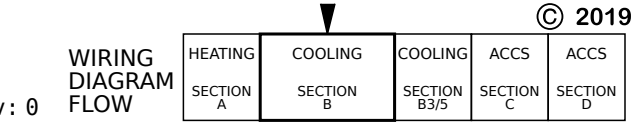
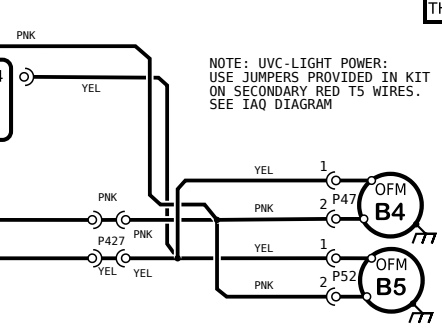

Product: LGM ALL UNIT J VOLT CONV KIT
 Cooling Diagram with Higher SCCR

Voltage: 575/3/60 (J)
 Supersedes: N/A
 Form No: 538430-01 Rev: 0



REV	EC NO.	DATE	BY	APVD	REVISION NOTE
0	CN-012439	12-06-2023	FEP	MCF	ORIGINATED AT PD&R CARROLLTON, TX

© 2019