

3PC/3WMC

Mini-Split

3 Ton Single Zone Heat Pump System - R-410A - 60Hz

RESIDENTIAL | COMMERCIAL
PRODUCT SPECIFICATIONS (EHB)



SEER2 - 20.0 | SEER - 17.5

HSPF2 - 7.9 | HSPF - 9.0

3 Tons

Cooling Capacity - 36,000 Btuh

Heating Capacity - 36,000 Btuh



3WMC036 Wall-Mounted
Non-Ducted Indoor Unit



Wireless
Remote Control
(furnished with
3WMC036 Wall-Mount
Non-Ducted Model)



3PC036 Heat Pump
Outdoor Units



MODEL NUMBER IDENTIFICATION

OUTDOOR SINGLE ZONE HEAT PUMP UNIT

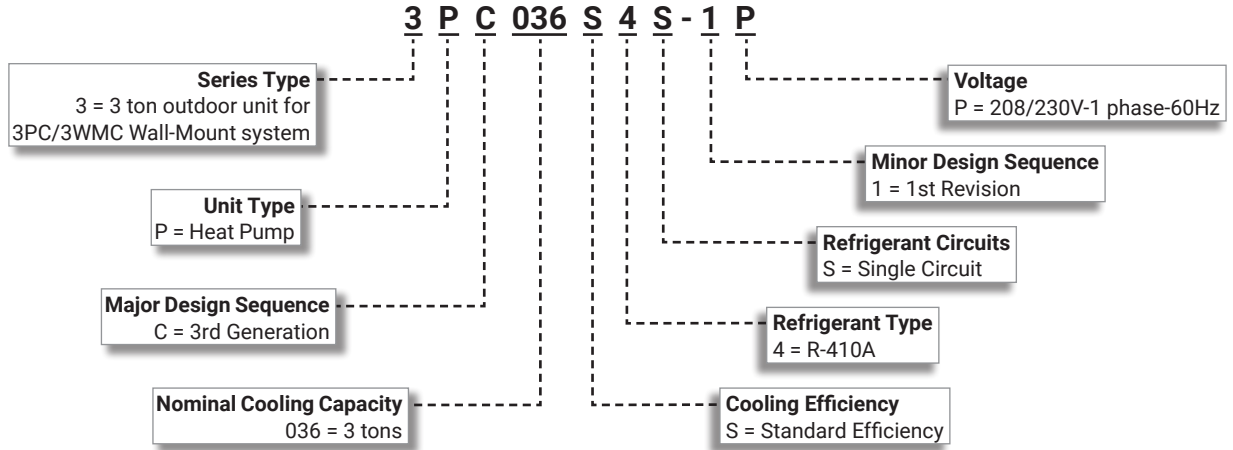

WALL-MOUNTED INDOOR UNIT

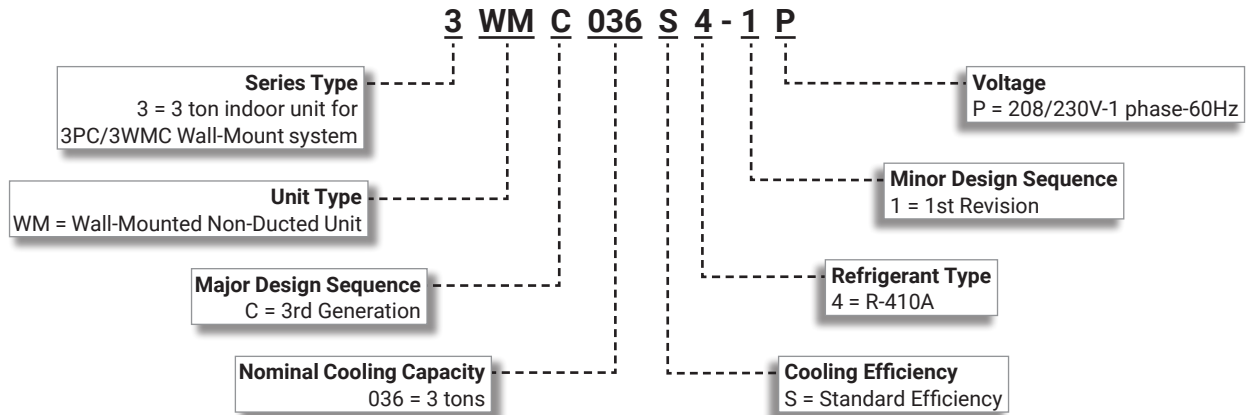

CONTENTS

Air Throw Data - Wall-Mounted Indoor Units	21
AHRI System Matches	16
Approvals And Warranty	3
Dimensions	18
- Outdoor Unit	18
- Wall-Mounted Indoor Unit.	19
- Wall-Mounted Indoor Unit - Wall Plate	19
Features - Indoor Units	5
Features - Outdoor Units	3
Installation Clearances	20
- Outdoor Unit	20
- Wall-Mounted Indoor Unit.	20
Line Set And Elevation Guidelines	21
Model Number Identification.	2
Optional Accessories - Order Separately	16
Remote Controller - Furnished	6
Remote Controllers - Optional	9
Specifications	15
- 3PC Outdoor Unit	15
- 3WMC Wall-Mounted Indoor Unit	15

APPROVALS AND WARRANTY

APPROVALS

NOTE - The 3PC036 outdoor unit can only be matched with the 3WMC036 indoor unit.

- AHRI Standard 210/240-2023 certified with Addenda 1 and 2
- ENERGY STAR® certified
- Rated According to U.S. Department of Energy (DOE) test procedures
- Indoor and outdoor units and components UL and CEC bonded for grounding to meet safety standards for servicing
- ETL certified for the U.S. and Canada
- Meets 2014 Florida Building Code Wind Design Criteria
 - Ultimate Wind Speed – 186 miles per hour
 - Risk Categories – III and IV
 - Wind Exposures – C and D
 - Mean Roof Heights – Up to 60 feet above ground

WARRANTY

- Compressor - Limited seven years
- All other covered components - Limited five years

NOTE - Refer to Lennox Basic Limited Warranty at www.Lennox.com for additional details.

FEATURES - OUTDOOR UNITS

APPLICATIONS

- 3 ton
- Single phase power supply (208/230V)
- Outdoor unit sound levels 61.5 dBA
- Indoor unit sound levels as low as 35.5 dBA
- Ductless mini-split system provides an alternative when a ducted system is impractical or cost prohibitive
- Units are shipped completely factory assembled, internally piped, and wired

NOTE - Outdoor unit is designed for outdoor location only.

REFRIGERATION SYSTEM

R-410A Refrigerant

- Non-chlorine, ozone friendly
- Unit is factory pre-charged

Outdoor Coil

- Aluminum fins fitted to copper tubes
- Wire grille guard provided

Outdoor Fan

- Direct drive fan moves large air volumes uniformly through entire outdoor coil for high refrigeration capacity
- Fan guard provided

Refrigerant Line Connections, Service Valve

- Flare connection lines are located on side of unit cabinet
- Fully serviceable brass service valve prevents corrosion and provides access to refrigerant system

COMPRESSOR

Variable Frequency Rotary Compressor

- Compressor features high efficiency operation
- Balanced for reduced vibration and quiet operation
- Brushless DC motor uses powerful Neodymium magnets, which are approximately 15-20 times stronger than ferrite magnets used in conventional AC compressors

Compressor Crankcase Heater

- Protects against liquid refrigerant migration that can occur during low ambient operation

CONTROLS

DC Inverter Control

- Provides continuous operation, while adjusting capacity according to room temperature
- The accurate sensing of cooling loads prevents frequent changes in capacity and ensures efficient, economical operation

Inverter Module Protection

- Protects against differences in current, voltage and temperature
- Displays code on the indoor unit indicating a need for servicing

Outdoor Unit Microprocessor

- Electronic expansion valve control
- Automatic compressor timed-off protection (3 minutes)
- Temperature sensor
- LEDs on control display error codes and assist in troubleshooting
- 4-Way reversing valve control

FEATURES - OUTDOOR UNITS

CONTROLS (continued)

Electronic Expansion Valve

- Furnished on all models

Compressor Overcurrent Protection

- Overcurrent protection can result due to any of the following:
 - Ambient temperature is too high
 - Locked rotor on the compressor
 - Outdoor air is blocked or restricted

Condenser High Temperature Protection

- Condenser high temperature can occur due to any of the following conditions:
 - High outdoor ambient
 - Outdoor fan blocked
 - Outdoor coil blocked
- The outdoor coil thermistor continuously monitors the temperature and communicates with the microprocessor
- Depending on the temperature measured, the compressor will be allowed to increase the frequency if needed to meet the load or is forced to run at the current or reduced frequency
- If the temperature becomes excessively high the compressor will be de-energized

Compressor Discharge Temperature Protection

- The compressor discharge line thermistor continuously monitors the temperature and communicates with the microprocessor
- Depending on the temperature measured, the compressor will be allowed to increase the frequency to meet the load or is forced to run at the current or reduced frequency
- If the temperature becomes excessively high, the compressor will be de-energized

Voltage Protection

- Protects unit from low or high voltage fluctuations

Terminal Strip

- Furnished for easy wiring connections

Defrost Control

- Defrost cycle is automatically enabled if there is a build-up of frost on the outdoor coil
- Outdoor fan operation is terminated during the defrost cycle
- Indoor fan changes to ultra low speed during the defrost cycle to help bring warm refrigerant back to the outdoor coil to assist during defrost operation
- Defrost LED is lit on the indoor unit panel on the front cover during a defrost cycle

Reversing Valve

- 4-way interchange reversing valve effects a rapid change in direction of refrigerant flow resulting in quick changeover from cooling to heating and vice versa
- Valve operates on pressure differential between outdoor unit and indoor unit of the system

CABINET

- Constructed of heavy gauge steel
- Tabs on unit base allow secure mounting to slab
- Condensate drain outlets furnished on unit base

NOTE - Drain must be field furnished.

- Pan heater prevents ice build-up in the bottom of the unit during heating operation
- Access cover for power and control wiring connections
- Access cover for service valves

FEATURES - INDOOR UNITS

WALL-MOUNTED INDOOR UNITS



- Low-sound, three-speed Wall Mount with LED display offers three access points for refrigerant outlet pipes: left, right or rear
- The front panel can be raised for accessible wiring and maintenance
- Swing louver angles to 90°
- Unit installs horizontally on a vertical wall
- **Pre-Heat Function** - Delays the operation of the fan until the indoor coil has reached a pre-determined temperature which prevents the discharge of cold air while the system is operating in the "heating" mode
- **LED Readout** - Mounted on unit. LED displays unit operation status, and codes for maintenance and servicing
- **Auto Restart** - Automatically restores the previous function setting if power is interrupted
- **Cooling Override** - Button on the indoor unit allows a temporary 30 minute override of the system for forced "AUTO" or "COOLING" operation
- **Flare Connections** - Equipped with liquid and gas flare fittings for quick and secure piping
- **Multi-Refrigerant Outlet** - Allows left, right, or rear access for refrigeration line connection
- **Three Speed Fan** - Fan functions at three speeds: low, medium and high
- **Air Filter** - Cleanable air filter is furnished as standard
- **Wireless Remote Controller** - Furnished as standard, see Page 6

REMOTE CONTROLLER - FURNISHED

WIRELESS REMOTE CONTROLLER (RG10L-WM)

(FURNISHED WITH WALL-MOUNT INDOOR UNITS)

- Complete remote control of system
- Maximum operating range is 25 ft.
- Operates on two AAA 1.5V batteries (furnished)
- Wireless remote controller holder furnished
- Holder can be mounted on a wall for easy access
- Mounting screws furnished

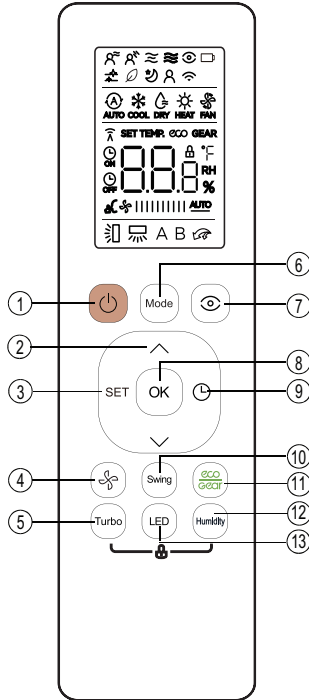

1 ON/OFF Button

- Turns system on and off

2 UP/DOWN Buttons ^ v

- Increase or decrease the indoor temperature in one degree increments (maximum 86°F, minimum 60°F)

NOTE - Temperature cannot be adjusted in FAN mode.

NOTE - Press and hold and buttons together for 3 seconds to alternate the temperature display between the °C and °F scale.

3 SET Button

- Scrolls through unit operations in this order:

1. Breeze Away
2. Active Clean
3. Sleep
4. Follow Me

NOTE - The selected symbol will flash on the display area. Press the OK button to confirm.

4 FAN Button

- Cycles fan speeds in the following order:
 - AUTO → 20% → 40% → 60% → 80% → 100%

5 TURBO Button

- Enables the unit to reach the preset temperature during cooling or heating operation in the shortest time

6 MODE Button

- Select system operation modes
- Press button to cycle through each setting:
 - AUTO → COOL → DRY → HEAT → FAN

7 ECO INTELLIGENT EYE Button

- Detects motion in the room to reduce cooling mode when no activity is detected for 30 minutes

8 OK Button

- Confirms selected function

9 TIMER Button

- Initiates an auto-on or auto-off time sequence
- Press TIMER button to initiate the ON time sequence
- Press Temp. up or down button for multiple times to set the desired time to turn on the unit
- Press TIMER button to initiate the OFF time sequence.

NOTE - Each press of the button increases or decreases the time (depending on function) in 30 minute increments up to 10 hours.

Above 10 hours each press of the button will increase or decrease the auto-timed setting by 60 minutes up to 24 hours.

To cancel, set timer to 0.0 or turn remote off and on.

10 SWING Button

- Used to stop or start louver auto swing feature

11 ECO/GEAR Button

- Controls temperature/energy efficiency of the unit

NOTE - Only available in cooling mode.

ECO Operation

- Sets unit to 75°F unit operation if setpoint is lower
- Sets fan to Auto operation if setpoint is over 75°F

NOTE - If setpoint is manually changed to less than 75°F, ECO operation is canceled.

GEAR Operation

- Reduces electrical consumption to 75% or 50%

12 HUMIDITY Button

- Adjusts the room humidity during DRY mode from 35% to 85%
- Each press of the button increases the humidity in 5% increments

13 LED Button











- Turns the LCD display backlight on the indoor unit on or off

NOTE - Press and hold the button for 5 seconds to display the actual room temperature. Press more than 5 seconds to revert back to display set temperature.

REMOTE CONTROLLER - FURNISHED

WIRELESS REMOTE CONTROLLER INDICATORS (RG10L-WM)

Information is displayed when the Wireless Remote Controller is powered on.

-  Not applicable for this unit
-  **Active Clean** feature display
-  **Breeze Away** feature display
-  Not applicable for this unit
-  Not applicable for this unit
-  **Sleep** feature display
-  Not applicable for this unit
-  **Follow Me** feature display
-  **ECO Intelligent Eye** display
(certain units)
-  Not applicable for this unit
-  Low battery detection (flashing)

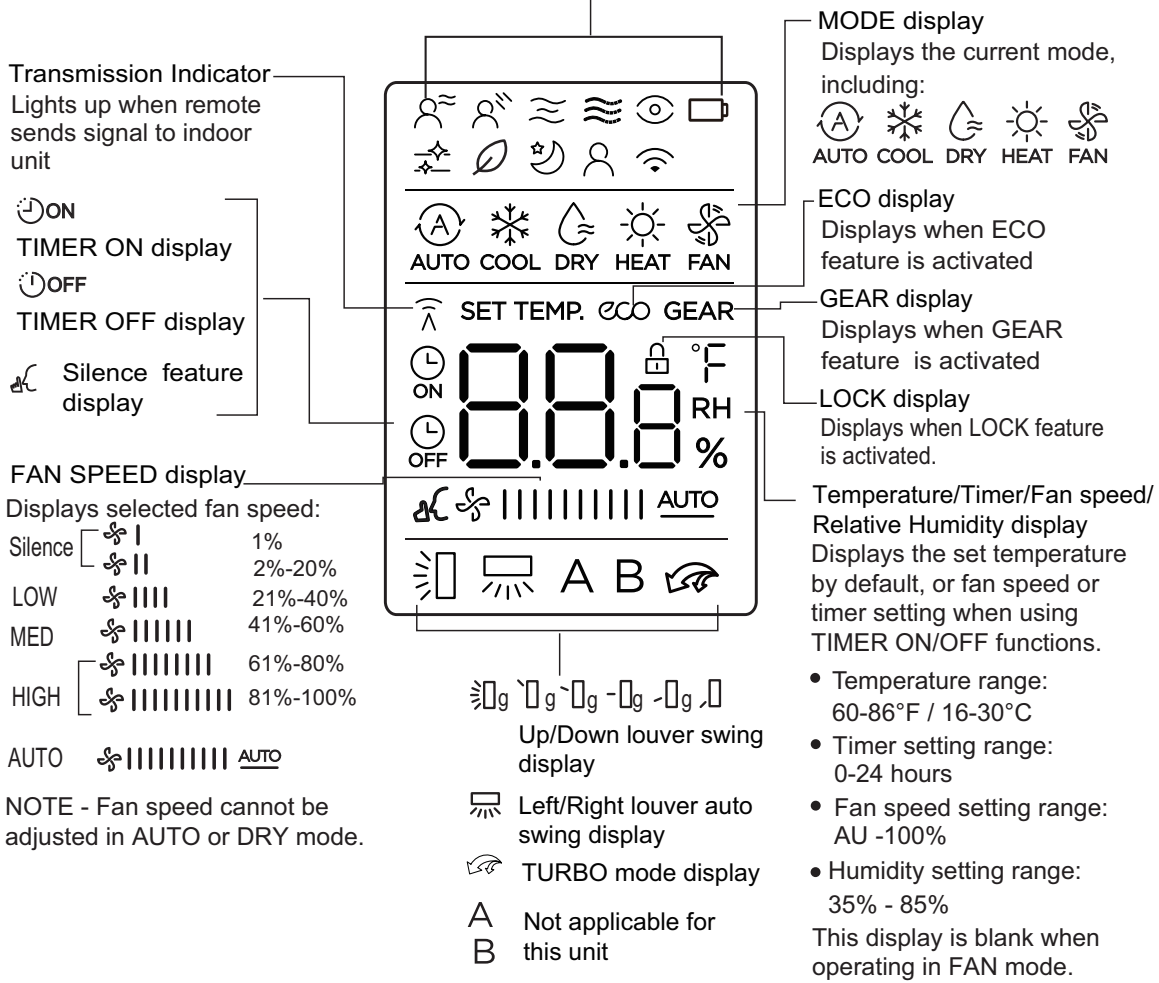

Note:
 All icons are shown for display purposes only.
 During actual unit operation, only active icons are displayed.

REMOTE CONTROLLER - FURNISHED

WIRELESS REMOTE CONTROLLER OPERATION (RG10L-WM)

Auto Operation

1. Press the **MODE** button to select Auto.
2. Press the **UP/DOWN** button to set the desired temperature.
3. Press the **ON/OFF** button to start the system.

Cooling /Heating/Fan Operation

1. Press the **MODE** button to select **COOL, HEAT** or **FAN** mode.
2. Press the **UP/DOWN** buttons to set the desired temperature.
3. Press the **FAN** button to select the fan speed.
4. Press the **ON/OFF** button to start the system.

Dehumidifying (DRY) Operation

1. Press the **MODE** button to select **DRY** mode.
2. Press the **UP/DOWN** buttons to set the desired temperature.
3. Press the **ON/OFF** button to start the system.

NOTE - Fan speed selection is disabled.

Timer ON/OFF Operation

1. Press the **TIMER** button. The remote controller shows **TIMER ON** or **TIMER OFF** icon
2. Press the **TIMER** button again to set desired time. Each time the button is pressed the time increases by 30 minutes between 0 and 10 hours and then by 60 minutes between 10 and 24 hours.
3. After setting the **TIMER ON** or **TIMER OFF** there will be a one second delay before the remote controller transmits the signal to the unit. After approximately 2 seconds the set temperature will re-appear on the LCD display window.

Silence Operation

1. Press the **FAN** button for more than 2 seconds to activate or disable the Silence function

Lock Function

1. Press the **TURBO** and **HUMIDITY** buttons together two times in less than one second to lock the Controller to prevent tampering
2. Press the **TURBO** and **HUMIDITY** together buttons again for two seconds to unlock the Controller

Swing Function

1. Press the **Swing** button to activate up/down louver operation. Louvers oscillate up and down automatically. Press and hold the **Swing** button again to disable.

NOTE - Pressing the **Swing** button multiple times will set the louvers at five different fixed airflow angles.

2. Press and hold **Swing** button for 2 seconds to activate left/right louver operation. Louvers swing left and right automatically.

SET BUTTON FUNCTIONS

Breeze Away

- Prevents unit from blowing air directly on a person

NOTE - Only available in **COOL, FAN** or **DRY** modes.

Active Clean

- Washes away dust, mold, and grease that may cause odors when it adheres to the indoor coil by automatically freezing and then rapidly thawing the coil
- Indoor unit displays "CL"
- After 20 to 45 minutes the unit will automatically turn cancel the operation

NOTE - Only available in **COOL** or **DRY** modes.

Sleep

- Enables the system to automatically increase cooling or decrease heating (in 2°F increments) per hour for the first 2 hours, then maintain a steady temperature for 5 hours
- System keeps the final operation mode after 8 total hours of operation

NOTE - To cancel, push the "MODE", "FAN SPEED" or "ON/OFF" buttons.

SLEEP mode is only available when the unit is in **COOL, HEAT** or **AUTO** mode

Follow Me

- Allows remote temperature sensing of the room at the remote controller location

REMOTE CONTROLLERS - OPTIONAL

WIRED REMOTE CONTROLLER (M0STAT120L-1)



FEATURES

- Built-In Memory - Maintains clock, fan speed and mode of operation settings following power outages
- Dimensions (H x W x D) - 4-3/4 x 4-3/4 x 7/8 in.
- Additional hardware is furnished for installation
- 3-1/2 in. back-lit LCD display screen
- Wiring - Controller uses 5-wire shielded 20 ft. cable (furnished) for easy low voltage connection to the indoor unit
- Maximum cable length is 59 ft.

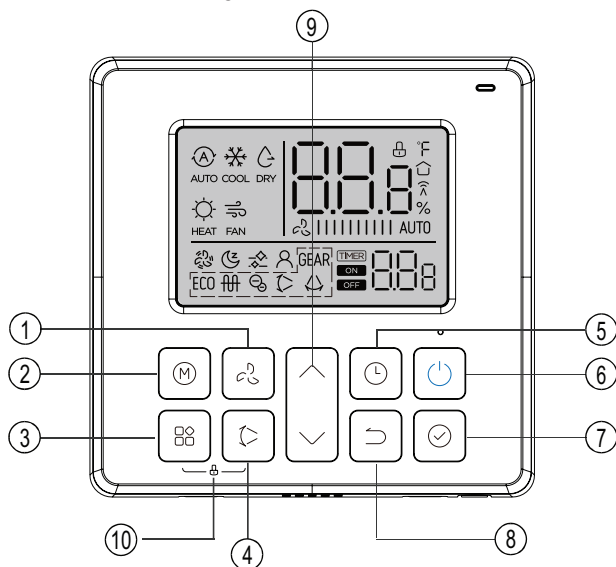

1 FAN SPEED Button

- Selects fan speed. Each button press cycles through the following settings on display

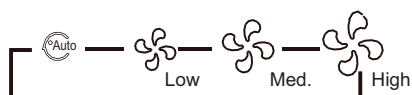

2 MODE Button

- Select system operation modes. Push button to cycle through each setting

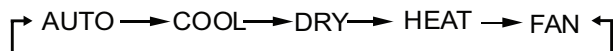

3 FUNCTION Button

- Scrolls through unit operations in this order:

1. Turbo
2. Sleep
3. Active Clean
4. Follow Me

4 SWING Button

- Used to stop or start louver auto swing feature (certain models)
- Louvers oscillate up and down automatically. Press and hold the Swing button again to disable.
- Pressing the Swing button multiple times will set the louvers at five different fixed airflow angles.
- Press and hold Swing button for 2 seconds to activate left/right louver operation. Louvers swing left and right automatically.

5 TIMER Button

- TIMER ON (initiates an auto-on time sequence)
- TIMER OFF (initiates an auto-off time sequence) can be used separately or together
- Each press of the button increases the time in 30 minute increments up to 10 hours
- Above 10 hours each press of the button will increase the auto-timed setting by 60 minutes up to 24 hours

6 POWER Button

- Turns system on and off

7 CONFIRM Button

- Confirms selected function

NOTE - Press and hold and **Arrow Up** Button and the **Arrow Down** button together for 3 seconds to alternate the temperature display between the °F and °C scale.

8 BACK Button

- Returns to the previous step

9 UP/DOWN Buttons

- Increase or decrease the indoor temperature in two degree increments (maximum 86°F, minimum 60°F).

NOTE - Temperature cannot be adjusted in FAN mode.

10 LOCK

- Press the **Function** and **Swing** buttons simultaneously to lock or unlock the Controller to prevent tampering with settings

OPTIONAL ACCESSORIES

Extension Cable for Wired Remote Controller

- 20 ft. cable for easy low voltage connection to the indoor unit
- Extends cable to maximum 65 ft. length

REMOTE CONTROLLERS - OPTIONAL

WIRED REMOTE CONTROLLER INDICATORS (M0STAT120L-1)

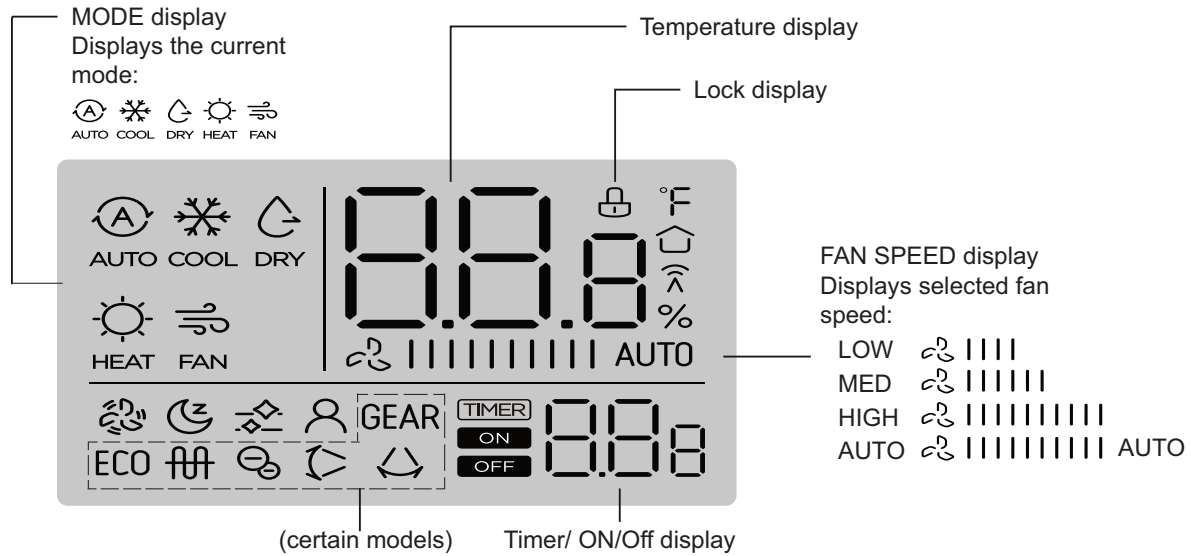

°F °F / °C display	Turbo feature display	GEAR GEAR feature display (certain models)
Room temperature display	Active clean display	ECO ECO feature display (on certain models)
Follow me feature display	SLEEP feature display	Electric heating display (certain models)
Not used	UP and down swing (certain models)	Left and right swing (certain models)

NOTE:
 All icons are shown for display purposes only.
 During actual unit operation, only active icons are displayed.

REMOTE CONTROLLERS - OPTIONAL

WIRED PROGRAMMABLE CONTROLLER (M0STAT120N-1)



FEATURES

- Wired programmable local controller for mini-split indoor units with convenient timed schedules for daily operation
- Weekly timers (2), all days of the week timer, up to 8 scheduled events per day
- Schedule start time, mode, setpoint, and fan speed
- Compatible with all indoor units
- Copy/paste function for easy duplication of events to other days
- Built-in system diagnostics
- 3-1/2 in. back-lit LCD display screen
- Controller uses 4-wire shielded 20 ft. cable (furnished) for easy low voltage connection to the indoor unit
- Adaptor cables are furnished for various indoor unit connections

NOTE - Cable for longer lengths must be ordered separately.

NOTE - Maximum cable length is 164 ft..

- Hardware for mounting furnished
- Mounts to standard electrical junction box (not furnished)
- Lithium battery furnished: CR2032
- Power Supply: 12 VDC
- Dimensions (H x W x D): 4-3/4 x 4-3/4 x 7/8 in.
- Audible tone when a button is pressed (can be disabled)
- Lock function disables buttons to prevent tampering

DISPLAY

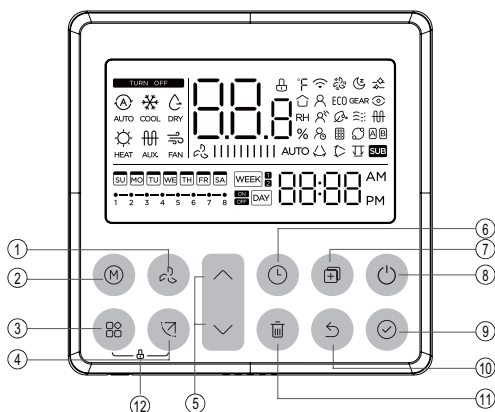

BUTTONS AND FUNCTIONS

- FAN SPEED Button**
 - Scroll through fan speeds (Auto - Low - Med - High)
- MODE Button**
 - Use + and - buttons to scroll through available operation modes (Auto / Cool / Dry / Heat / Fan)
- FUNCTION Button**
 - Scrolls through unit operations in this order:
 1. Turbo
 2. Sleep
 3. Follow Me
- SWING Button**
 - Used to stop or start louver auto swing feature (certain models)
 - Louvers oscillate up and down automatically. Press and hold the Swing button again to disable.
 - Pressing the Swing button multiple times will set the louvers at five different fixed airflow angles.
 - Press and hold Swing button for 2 seconds to activate left/right louver operation. Louvers swing left and right automatically.
- UP/DOWN Buttons**
 - Increase or decrease the indoor temperature in one degree increments (maximum 86°F, minimum 60°F).

NOTE - Temperature cannot be adjusted in FAN mode.
- TIMER Button**
 - Sets unit for daily or weekly on/off operation
- COPY Button**
 - Copy schedules from one day to another
- POWER Button**
 - Turn system on and off
- CONFIRM Button**
 - Confirms each step when managing schedules

NOTE - Press and hold and **Confirm** Button and the **Arrow Down** button together for 3 seconds to alternate the temperature display between the °F and °C scale.
- BACK Button**
 - Returns to the previous step
- DAY OFF/DELAY BUTTON**
 - Disable specific days/schedules of the week
 - Delete a specific event
- LOCK**
 - Press the **Function** and **Swing** buttons simultaneously to lock the Controller to prevent tampering with settings

OPTIONAL ACCESSORIES

Extension Cable for Wired Programmable Controller

- 20 ft. cable for easy low voltage connection to the indoor unit
- Extends cable to 40 ft. (12 m) length

REMOTE CONTROLLERS - OPTIONAL

WIRED PROGRAMMABLE REMOTE CONTROLLER INDICATORS (M0STAT120N-1)

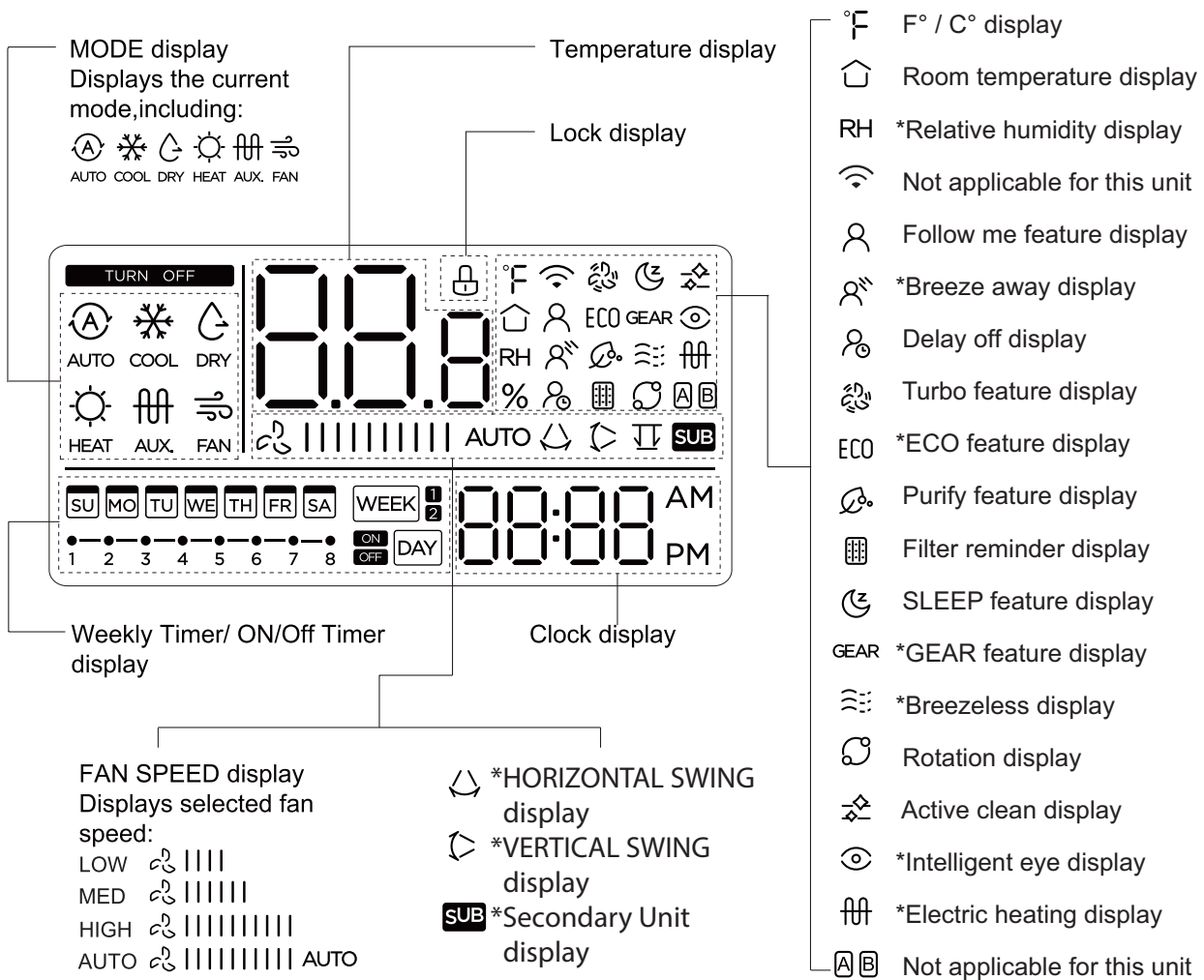

NOTE:

All icons are shown for display purposes only.
 During actual unit operation, only active icons are displayed.

**Certain Models*

OPTIONAL ACCESSORIES - ORDER SEPARATELY

OUTDOOR UNITS

Condenser Pad

- Provides permanent foundation for outdoor units
- One-piece lightweight structural foam and molded from high-density polyethylene (HDPE)
- Lightweight, easy to carry and install
- Textured finish provides a non-skid surface so outdoor unit sits securely in one place
- UV stable

Disconnects

- Positive unit disconnect
- Single door enclosure
- Fused and non-fused models available

Fuses

- 30 and 60 amp fuses available

Indoor/Outdoor Wiring Cable

- 14-gauge, 4-conductor wire
- THHN (Thermoplastic High Heat-resistant Nylon-coated) wire
- Suitable for wet or dry locations
- Rated up to 600V

Refrigerant Line Sets

- Refrigerant lines are shipped refrigeration clean
- Lines are cleaned, dried, pressurized and sealed at factory

Wall Brackets

- Heavy duty 1/8 in. thick steel brackets for supporting outdoor units
- Mount at any height to allow for easy maintenance under units
- Pre-punched holes for easy installation
- Powder coated gray finish
- Load rating 600 lbs. per pair

Whips

- Heavy duty electrical whips are available in 8 and 10 gauge sizes
- 6 ft. lengths
- Weatherproof metal conduit

INDOOR UNITS

Condensate Pumps

- Quietly and efficiently removes condensate
- See Optional Accessories Table for available pumps

A/C Easy Tee® Condensate Cleanout

- Condensate drain service port
- Flexible and easy to use with nitrogen, water or shop vac
- Screw cap on top allows easy access to condensate drain line

SPEEDICHANNEL™ SYSTEM



- SpeediChannel™ is a channel system covers system line sets
- Two-part system has a base and a cover
- Base is fastened to a wall or ceiling with plastic clips (SpeediClip™) that snap into a channel already molded into the base
- Cover fits on top of the base
- Manufactured from rigid PVC, which is UL rated and resistant to UV light
- System is a natural color that closely matches typical mini-split outdoor units
- Can be painted as desired to match any wall color

Typical Application

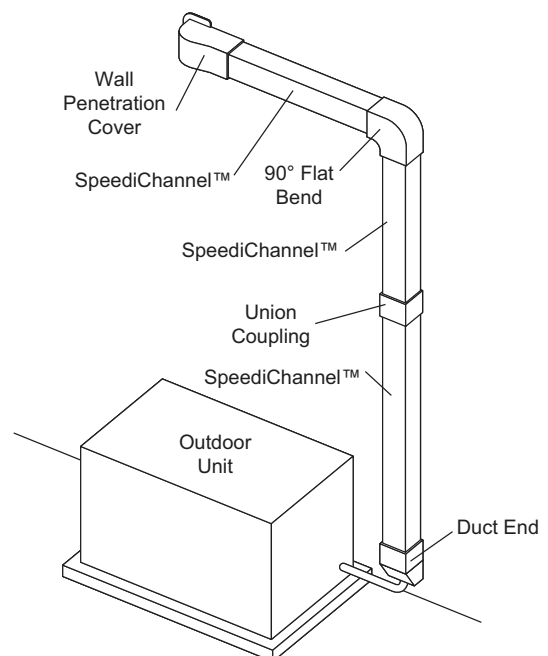

OPTIONAL ACCESSORIES - ORDER SEPARATELY

SPEEDICHANNEL™ SYSTEM (continued)

SpeediChannel™ Starter Kit

- The starter kit includes (1) Coupling, (1) Wall Penetration, (1) Inside Elbow, (1) Long Radius Flat Bend, (10) Speediclips™, (10) 11 in. Cable Ties, and (1) SpeediChannel Instruction Booklet

Duct End

- Duct Ends are used to terminate a run of SpeediChannel™ to a small opening just large enough for the line set and condensate drain line to pass through



Flat Wall Escutcheon

- Flat Wall Escutcheons are used to cover a rough opening in a soffit, wall, or ceiling penetration



- One side of the escutcheon is flat to allow for a SpeediChannel™ to run along a wall and to penetrate through an adjacent wall or ceiling
- This is the most common type of wall penetration
- Furnished in two parts, the escutcheon easily snaps onto the SpeediChannel™

Flex Joint

- A Flex Joint is an accordion-style piece of SpeediChannel™
- The flex joint can be extremely flexible when routing a SpeediChannel™ system around an obstacle
- Each joint is 20 in. long and can be combined together for longer flex runs
- The flex joint does not require the use of a union coupling
- The flex joint slides tightly inside the SpeediChannel™ system

T-Joint

- T-Joints are used for creating a tee connection between three pieces of SpeediChannel™
- Each tee is individually packed and furnished with stainless steel screws

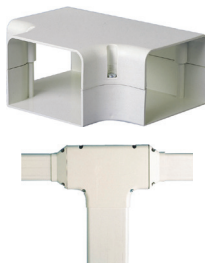

Union Coupling

- Union Couplings are used for joining two pieces of SpeediChannel™
- Each coupling is individually packed and furnished with stainless steel screws



Wall Penetration Cover

- Wall penetration covers are used to transition from the SpeediChannel™ system to a through wall penetration
- Wall covers are designed to allow for easy installation, even after the line set has been installed
- A hooking and fastening arrangement allows for quick installation
- Each wall cover is individually packed, and furnished with stainless steel screws to attach the wall cover to the base
- Three screws are necessary to fasten the wall cover to the wall construction, regardless of the type of installed system



45° and 90° Flat Bend Elbows

- 45° Flat Bends are used to route the SpeediChannel™ around obstacles
- Each bend is individually packed and furnished with stainless steel screws

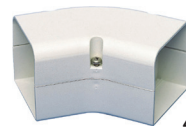

45°



90°

90° Inside Elbow

- 90° Inside Elbows are used to route the SpeediChannel™ around an inside corner
- Each elbow is individually packed and furnished with stainless steel screws

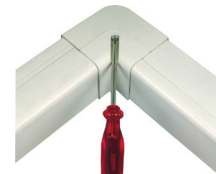

Mount Block White Qty. (2) 14 in. and (2) 36 in.

- Mount Blocks are used as mounting bases when outdoor units must be bolted down
- End caps (for aesthetics) come furnished with mounting bolts
- Maximum load capacity is 900 pounds per mounting block
- Installation temperatures range from -4°F to 140°F
- Mount blocks fit all mini-split outdoor units with a sliding rail feature



SPECIFICATIONS

3PC OUTDOOR UNIT



Model		3PC036S4S
Nominal Tonnage		3
Ambient Temperature Operating Range - °F	Cooling	5 - 122
	Heating	5 - 86
Energy Star		Yes
Sound Data (dBA)	Cooling/Heating	61.5
Refrigerant (R-410A)	Charge furnished	7 lbs. 5 oz.
Maximum line length with furnished charge - ft.		30
Additional charge required per ft. - oz.		0.32
Compressor	Type	(1) Rotary
	Refrigerant oil type	VG74
	Refrigerant oil charge - oz.	22.7
Connections - in.	Liquid/Gas pipe (flare) - in.	3/8 / 5/8
	Maximum refrigerant pipe length - ft.	213
	Max. difference in level of indoor unit - ft.	98
Outdoor Fan(s)	Diameter - in.	(1) 22
	Total air volume - cfm	2235
	rpm	1150
Outdoor Coil	Number of rows	3
	Fins per inch	18
	Fin type	Hydrophilic aluminum
	Tube outside diameter - in.	5/16
	Tube type	Rifled copper tubing
Net face area - ft. ²		8.14
Design Pressure	PSIG	550 / 340
Shipping Data	Net/Shipping weight (lbs.)	150 / 159
ELECTRICAL DATA		
Line voltage data (Volts-Phase-Hz)		208/230-1-60
¹ Maximum Overcurrent Protection (amps)		35
² Minimum circuit ampacity		28
Outdoor Fan Motor	Rated load amps	0.5
	Output - W	120

NOTE - Extremes of operating range are plus and minus 10% of line voltage.

¹ HACR type circuit breaker or fuse.

² Refer to National or Canadian Electrical Code manual to determine wire, fuse and disconnect size requirements.

SPECIFICATIONS

3WMC WALL-MOUNTED INDOOR UNIT



Model		3WMC036S4
Nominal Tonnage		3
Line voltage data (Volts-Phase-Hz)		208/230-1-60
Rated load amps		0.55
Output (W)		58
Room Temperature Range (°F)	Cooling	60 - 90
	Heating	32 - 86
Air Volume - cfm (High/Medium/Low)		639 / 506 / 382
Sound Data (dBA) - Low/Medium/High		47.5 / 42 / 35.5
Piping Connections - Liquid/Gas (OD) flare - in.		3/8 / 5/8
Drain connection o.d. - in.		1
Shipping Data	Net/Shipping weights - lbs.	44 / 55

AHRI SYSTEM MATCHES

Outdoor Unit	Indoor Unit	2017						2023					AHRI Reference Number
		Cooling Cap.	SEER	EER	Heat Capacity		HSPF (IV)	Cooling Cap.	SEER2	EER2	High Heat	HSPF2 (IV)	
					High	Low							
3PC036S4S-1P	3WMC036S4-*P	36000	17.5	8.5	36000	22400	9	36000	20	8.5	36000	7.9	210665608

Ratings are AHRI certified to AHRI Standard 210/240 with Addenda 1 and 2;

- Cooling Ratings - 80°F dry bulb/67°F wet bulb entering indoor coil air and 95°F wet bulb/75°F dry bulb outdoor air temperature.
- High Temperature Heating Ratings - 70°F dry bulb/60°F wet bulb entering indoor coil air and 47°F dry bulb/43°F wet bulb outdoor air temperature.
- Low Temperature Heating Ratings - 70°F dry bulb/60°F wet bulb entering indoor coil air and 17°F dry bulb/15°F wet bulb outdoor air temperature.

To convert HSPF from Region IV to Region V - Divide by 1.15.

OPTIONAL ACCESSORIES - ORDER SEPARATELY

Description	Catalog No.	Size 36
OUTDOOR UNIT		
Condenser Pad (18 x 38 x 3)	Y5014	•
Disconnects	30 amp, fused, 1 ph	27P37
	60 amp, non-fused, 1 ph	27P39
Fuses	30A	83P75
	60A	83P77
Hail Guards (H x W)	(1) 28-7/8 x 28-1/2 in. + (1) 12-1/2 x 28-1/2 in.	15D28
Line Sets	3/8 in. x 5/8 in. x 25 ft.	X8406
	3/8 in. x 5/8 in. x 50 ft.	X8407
Wall Brackets	36 inch	X1728
Whips	10 Gauge - 1/2 in. x 6 ft.	29P54
	8 Gauge - 3/4 in. x 6 ft.	27P44
INDOOR UNIT		
¹ Diversitech Condensate Pumps with Reservoir	Mini-Split Pump - 4 US gallons per hour, 20 ft. lift - 230V	Y7949
	ClearVue Mini™ - 7.9 US gallons per hour, 35 ft. lift - 120/240V	Y5170
Blue Diamond® Condensate Pumps with Reservoir	MaxiBlue® - 3.7 US gallons per hour, 16.5 ft. lift - 208-230V	14T69
	MultiTank Kit	14T75
A/C Easy Tee® Condensate Cleanout		Y7947
CONTROLS		
Wired Remote Controller	M0STAT120L-1	24X02
Extension Cable for Wired Remote Controller - 20 ft.		Y8008
Wired Programmable Controller	M0STAT120N-1	24X03
Extension Cable for Wired Programmable Controller - 20 ft.	M0CTRL64Q-1	Y8738
Indoor/Outdoor Wiring Cable - 14 Gauge, 4 conductor wire, THHN, 250 ft.		Y2067
SPEEDICHANNEL™ SYSTEM		
SpeediChannel™ Starter Kit - 4 in.		Y3387
SpeediChannel - 4 in. x 6-1/2 ft. (qty. 6)		Y3388
Union Coupling - 4 in.		Y3389
90° Flat Bend Elbow - 4 in.		Y3390
90° Inside Elbow - 4 in.		Y3391
45° Flat Bend Elbow - 4 in.		Y3392
Flex Joint - 4 in.		Y3393
T-Joint - 4 in.		Y3394
Duct End - 4 in.		Y3395
Flat Wall Escutcheon - 4 in.		Y3396
Wall Penetration Cover - 4 in.		Y3399
Mount Block (White) Qty, 2 - 14 in.		Y3397
Mount Block (White) Qty, 2 - 36 in.		Y3398

¹ Y7949 condensate pump can be installed inside the indoor unit. All other pumps must be installed external to the indoor unit.

COOLING CAPACITY

036

Outdoor Temperature - °F (Dry Bulb)	Indoor Temperature - °F (Dry Bulb / Wet Bulb)							
	65°F / 54°F		70°F / 59°F		75°F / 63°F		80°F / 67°F	
	Total mBtuh	Sensible mBtuh	Total mBtuh	Sensible mBtuh	Total mBtuh	Sensible mBtuh	Total mBtuh	Sensible mBtuh
-22	29.82	18.53	31.26	19.31	33.11	20.36	35.22	21.52
-13	31.05	19.68	32.82	20.69	34.73	21.76	36.37	22.66
-4	31.67	20.72	33.13	21.53	34.58	22.37	36.79	23.66
0	31.61	21.76	33.63	23.04	35.03	23.86	36.91	24.99
5	30.88	21.79	32.75	23.00	34.84	24.33	37.02	25.73
17	32.00	22.24	33.37	23.07	35.23	24.23	37.32	25.53
25	32.68	23.61	34.26	24.64	35.91	25.70	37.68	26.79
35	32.32	23.91	34.35	25.28	36.50	26.73	38.06	27.71
47	33.32	25.23	34.93	26.33	37.16	27.87	38.75	28.91
55	33.81	25.48	35.85	26.90	37.74	28.18	39.56	29.39
65	35.40	26.64	37.07	27.74	38.69	28.83	40.43	29.96
75	35.82	28.10	37.58	29.32	39.19	30.40	41.25	31.85
85	34.80	28.04	36.59	29.30	38.47	30.64	40.58	32.14
95	32.83	26.57	34.63	27.86	36.60	29.26	38.86	30.89
105	31.34	26.85	33.13	28.25	34.77	29.50	36.99	31.18
115	29.14	27.32	30.61	28.57	32.12	29.84	33.81	31.24
122	27.45	27.35	28.71	28.50	30.22	29.89	31.98	31.50

HEATING CAPACITY

036

Outdoor Temperature - °F (Dry Bulb)	Indoor Temperature - °F (Dry Bulb)			
	60°F	65°F	70°F	75°F
	Total mBtuh	Total mBtuh	Total mBtuh	Total mBtuh
-22	14.77	14.37	13.94	13.34
-13	16.09	15.63	15.24	14.67
-4	17.64	17.21	16.66	15.97
0	19.81	19.24	18.73	17.94
5	21.65	21.04	20.43	19.69
17	22.67	22.01	21.48	20.51
20	24.17	23.53	22.87	22.05
25	25.86	24.99	24.26	23.41
32	27.07	26.36	25.59	24.54
35	28.44	27.75	26.89	25.68
40	34.58	33.47	32.40	30.98
47	39.30	38.16	37.01	35.35
50	39.67	38.63	37.61	36.26
57	40.52	39.15	38.12	36.79

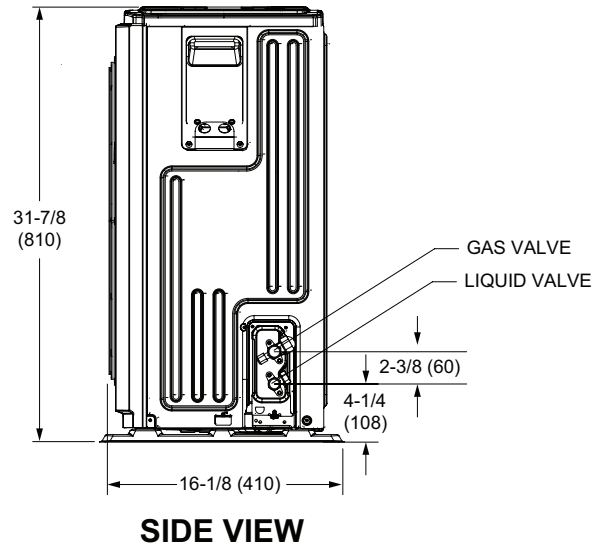
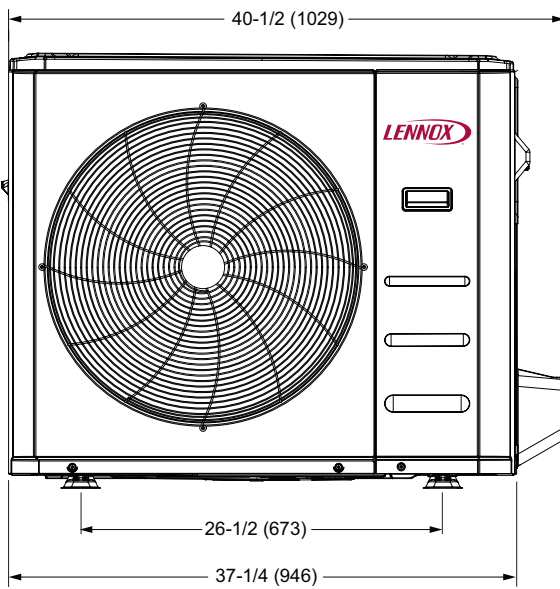
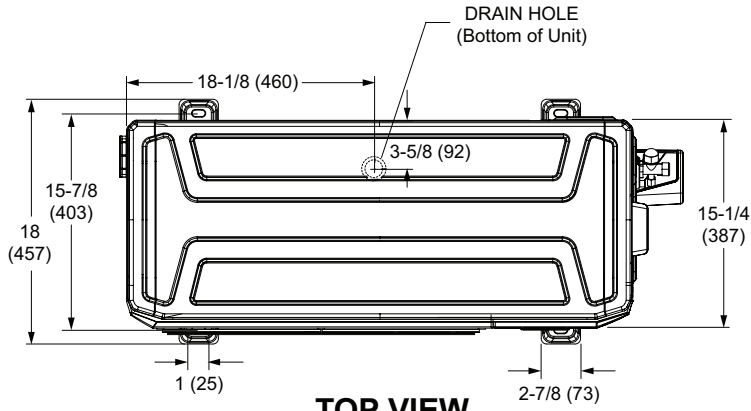

DIMENSIONS

WALL-MOUNTED INDOOR UNIT

3WMC036S4

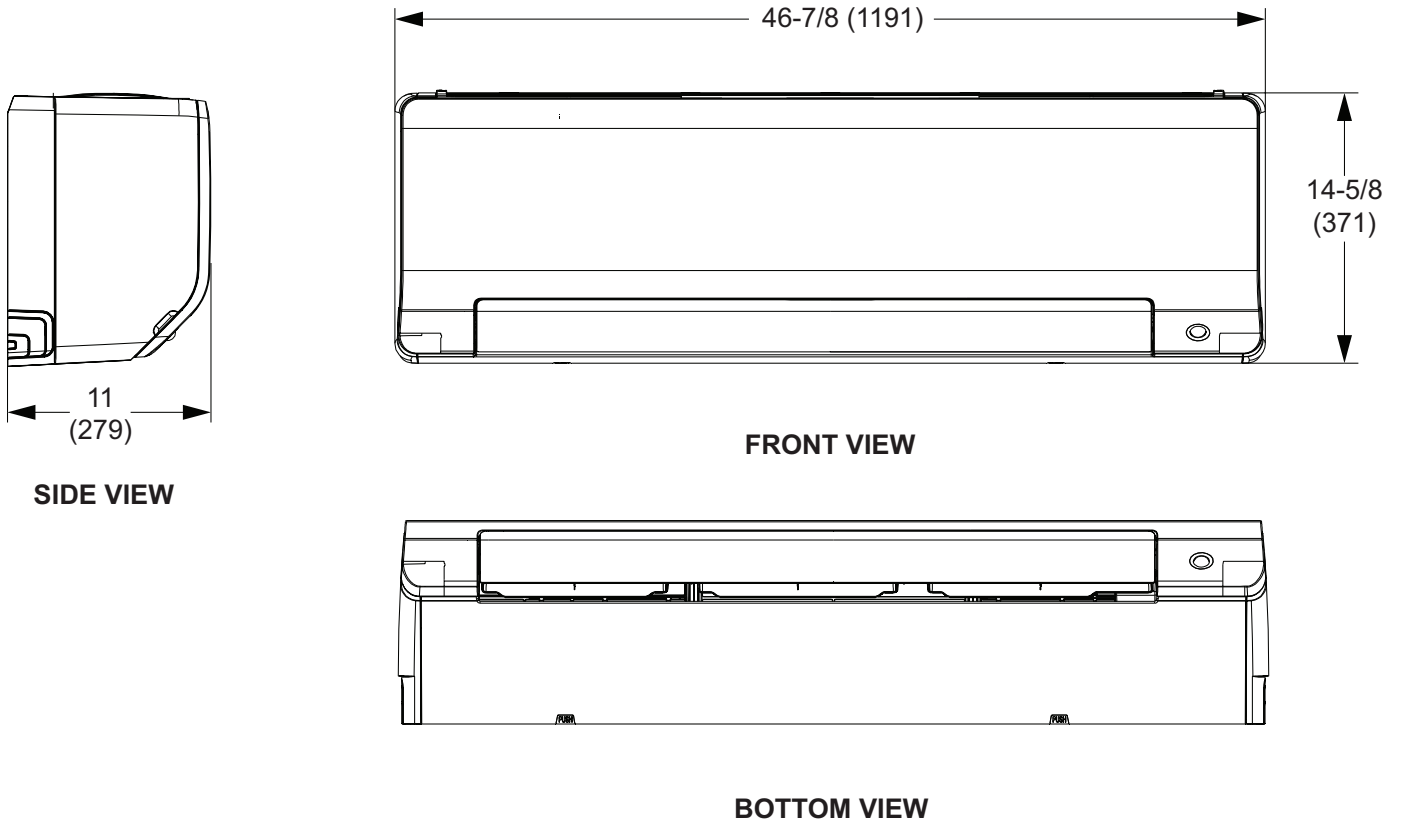

DIMENSIONS

WALL-MOUNTED INDOOR UNIT - WALL PLATE

3WMC036S4

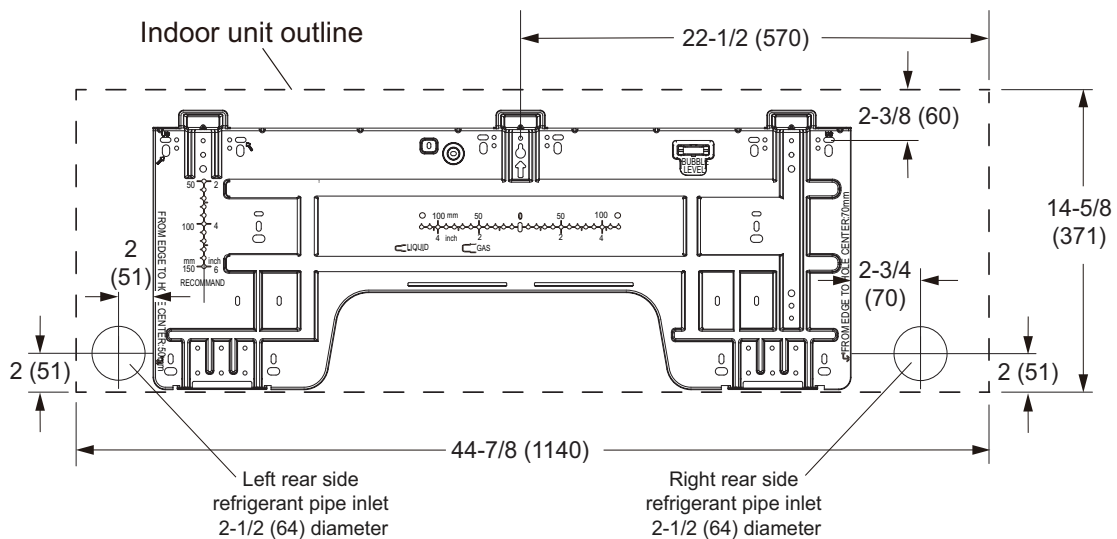

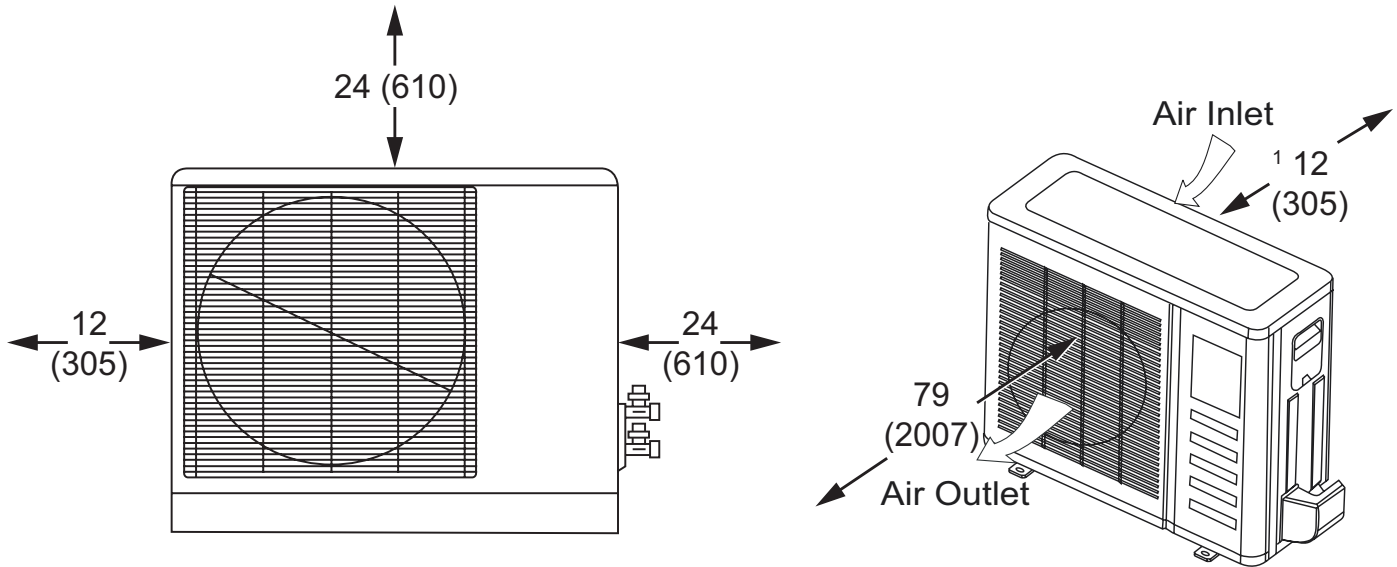

¹ Minimum rear clearance can be 6 inches (152 mm) when mounted on brackets and with no obstructions on the other three sides.

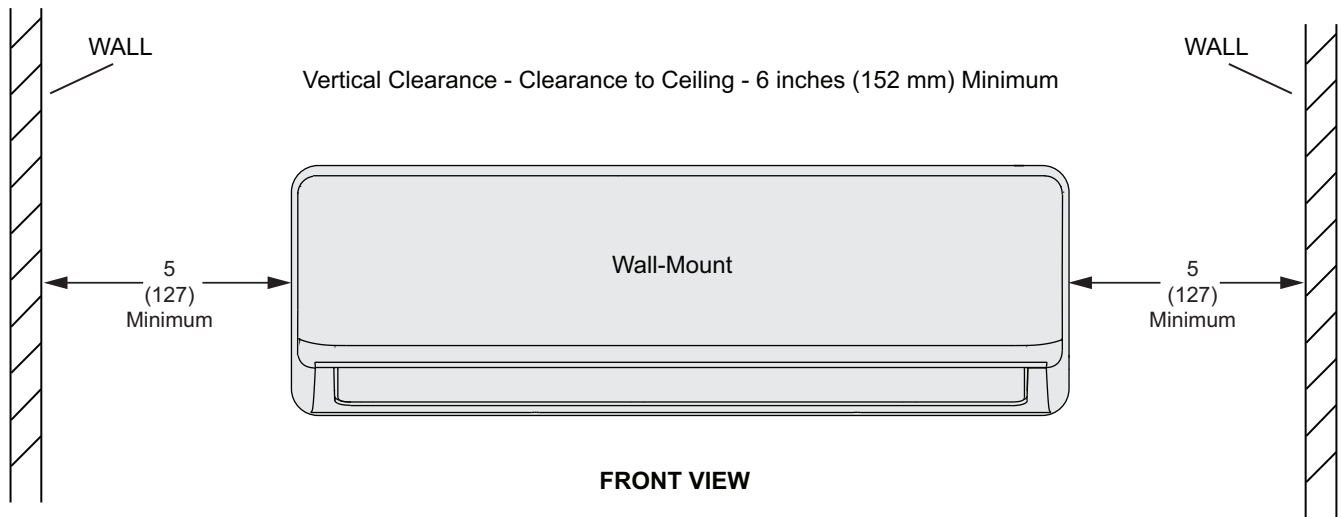

Vertical Clearance - Clearance to Floor - 72 inches (1829 mm) Minimum
 NOTE - Provide 96 inches (2438) clearance to floor for best performance

AIR THROW DATA - WALL-MOUNTED INDOOR UNITS

3MWMC036S4-1P - COOLING

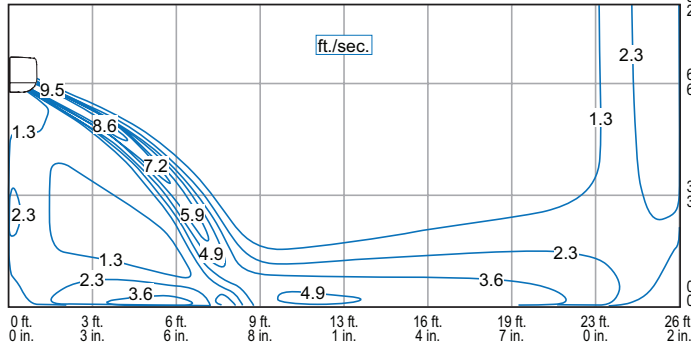

3MWMC036S4-1P - HEATING

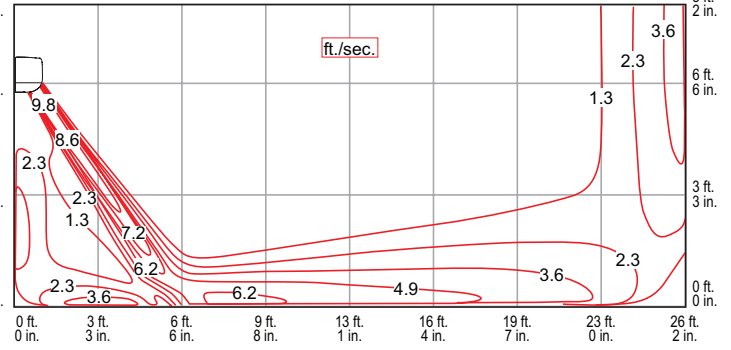

LINE SET AND ELEVATION GUIDELINES

Outdoor Unit BELOW Indoor Unit

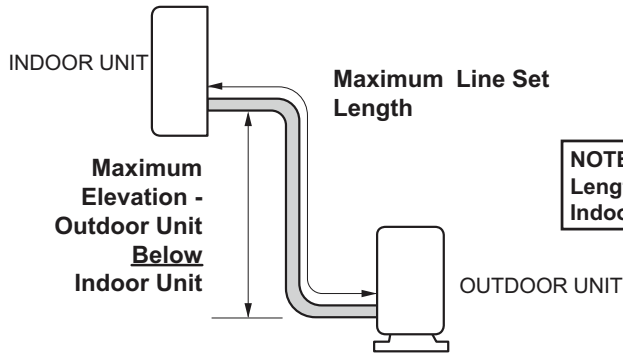

Outdoor Unit ABOVE Indoor Unit

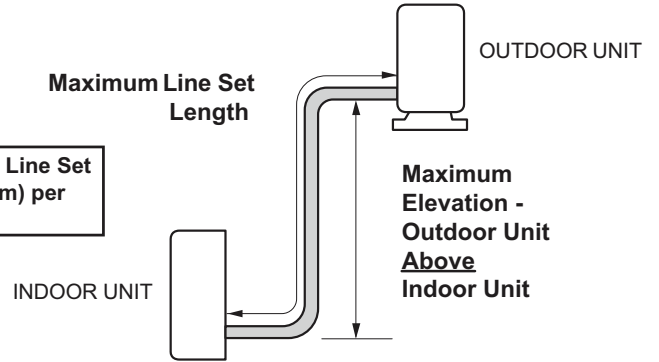

NOTE - Minimum Line Set Length - 10 ft. (3 m) per Indoor Unit

Size	Line Set Diameters (in.)		Maximum Elevation - Outdoor Unit <u>Below</u> Indoor Unit ft. (m)	Maximum Elevation - Outdoor Unit <u>Above</u> Indoor Unit ft. (m)	Maximum Line Set Length ft. (m)
	Liquid	Gas			
036	3/8	5/8	98 ft. (30 m)	98 ft. (30 m)	213 ft. (65 m)



Visit us at www.Lennox.com

For the latest technical information, www.LennoxCommercial.com

Contact us at 1-800-4-LENNOX

NOTE - Due to Lennox' ongoing commitment to quality, Specifications, Ratings and Dimensions subject to change without notice and without incurring liability. Improper installation, adjustment, alteration, service or maintenance can cause property damage or personal injury. Installation and service must be performed by a qualified installer and servicing agency.

©2023 Lennox Industries, Inc.